

Data Sheet for Product

Part Number : WS45N1F-YA03A-T



The Component corresponds with display's hazardous substance management standard and complies with RoHS and Halogen free.

WOREE E&L Co.,Ltd.

636-3, Sunggok-dong, Danwon-gu, Ansan-si, Kyunggy-do, Korea. Tel (031)599-3013 Fax (031)494-3174

CONTENTS

- 1. Features**
- 2. Outline Dimension**
- 3. Material Information**
- 4. Absolute Maximum Ratings**
- 5. Electrical / Optical Characteristics**
- 6. Rank Information**
- 7. Characteristic Diagrams**
- 8. Reliability**
- 9. Soldering Information**
- 10. Packaging & Label**

1. Features

- SMD Side View Type with Lead Frame Base
- Long Time Reliability
- Package size is 4.0 * 1.0* 0.5t (mm)
- Application : Navigation & NetBook, NoteBook PC BLU

2. Outline Dimension

Unit : mm

Tolerance : ± 0.1

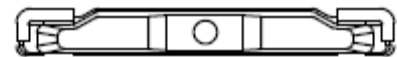
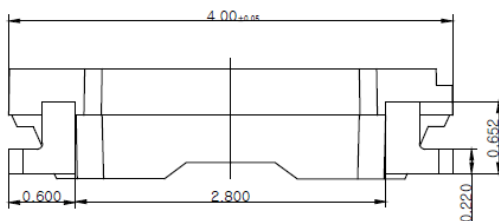
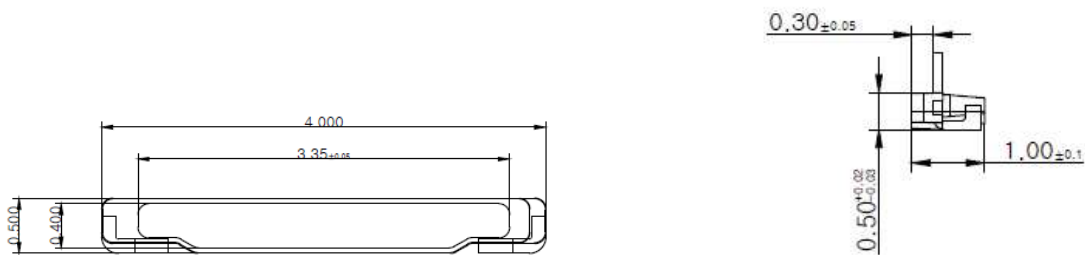

Circuit Diagram

Anode \rightarrow Cathode

3. Material Information

Item	Chip		Paste		Lead Frame		Phosphor	Encap	Wire
	LED	Zener	LED	Zener	Reflector	Metal			
Material	InGaN	無	Clear Paste	無	PPA	Copper alloy	Yellow, Green, Red	Silicone	Gold

4. Absolute maximum ratings

Item	Symbol	Absolute Maximum Ratings	Unit
Forward Current	I_F	20	mA
Power Dissipation	P_D	60	W
Reverse Current	I_R	50	mA
Pulse Forward Current *1	I_{FP*1}	100	mA
Operating Temperature	T_{opr}	-40 ~ +85	°C
Storage Temperature	T_{stg}	-40 ~ +100	°C
Solder Temperature	T_{sld}	Reflow 260 °C,10sec under Hand 340 °C 3sec under	°C

*1. Pulse Width ≤ 10msec, Duty ≤ 10%

5. Electrical/Optical characteristics

(Ta=25°C)

Item	Symbol	Condition	Value			Unit	
			Min	Typ	Max		
Luminous Intensity *1	cd	IF=20mA	2,400	2,750	-	mcd	
Luminous Flux *1	Φ_v	IF=20mA	7.1	8.1		lm	
Forward Voltage *2	V_F	IF=20mA	2.7	-	3.1	V	
Forward Voltage	V_{FL}	IF=10uA	2.2	-	2.5	V	
Chromaticity Coordinate *3	-	IF=20mA	X	-	0.292	-	-
			y	-	0.273	-	-
Reverse Current	IR	VR=5V	-	-	50	uA	
View Angle	Peak	IF=20mA	-	120	-	Deg.	
Life Time*4	-	Tj max. 70°C	10,000	-	-	hr	
ESD	-	-	2	-	-	KV	

*1. Luminous Intensity measurement allowance is $\pm 5\%$

*2. Forward voltage(VF) measurement tolerance: $\pm 0.05V$ / VFL: $\pm 0.03V$

*3. CIE coordinates measurement tolerance: ± 0.005

*4. Estimated Time to 50% degradation for initial luminous intensity.

6. Rank Information

(1) Luminous Intensity

Rank	Condition	Luminous Intensity [cd]	Luminous Flux [lm]
240	IF =20mA	2.4-2.5	5.8-6.1
250		2.5-2.6	6.1-6.3
260		2.6-2.7	6.3-6.5
270		2.7-2.8	6.5-6.8
280		2.8-2.9	6.8-7.0
290		2.9-3.0	7.0-7.3
300		3.0-3.1	7.3-7.5
310		3.1-3.2	7.5-7.7

(2) Forward Voltage

Code	Condition	Min.	Max.	Unit
7	IF=20mA	2.7	2.9	V
9		2.9	3.1	

(4) Chromaticity Coordinates Diagram

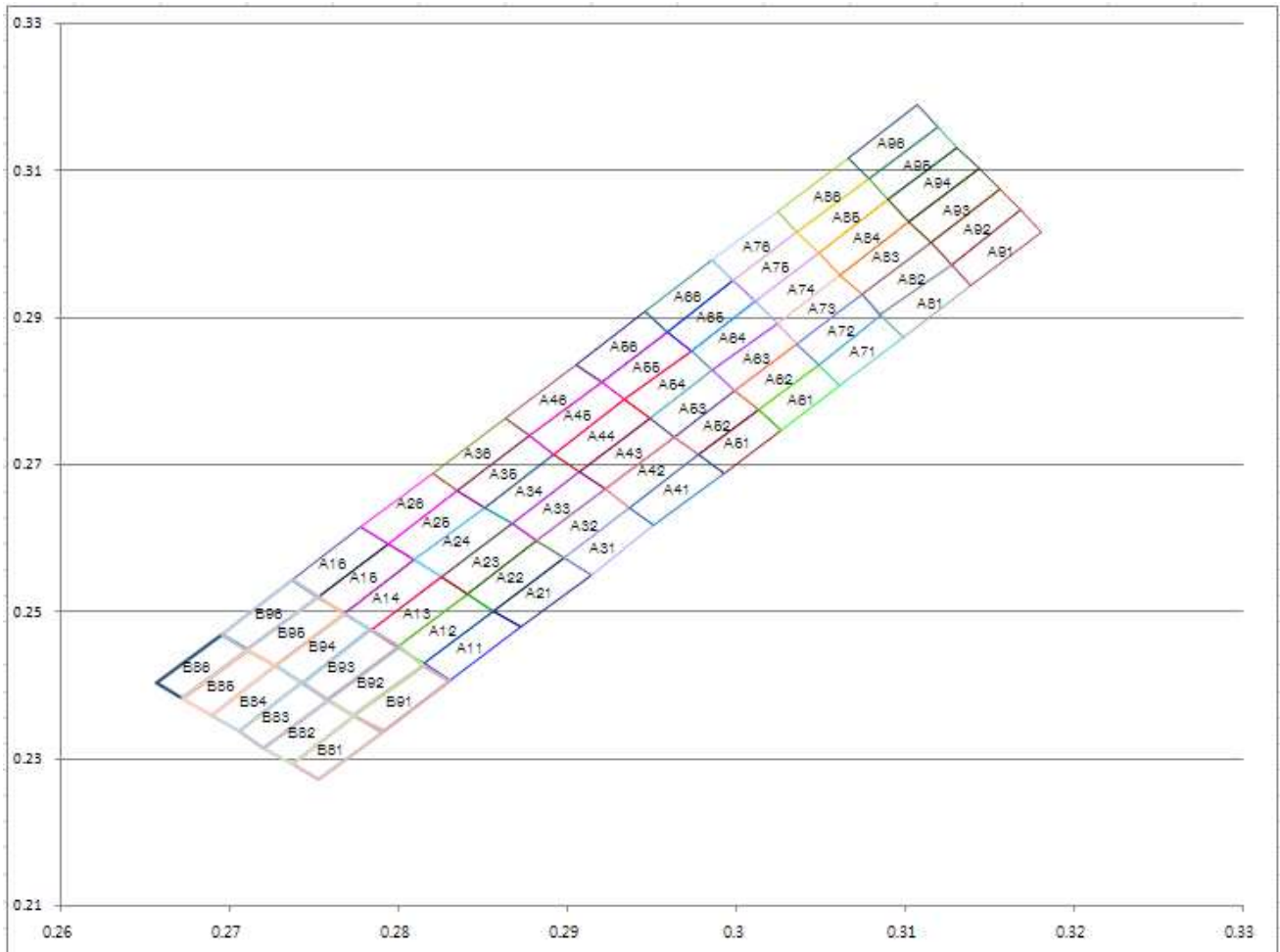

7.Characteristic Diagrams

(1) Forward Voltage vs Forward Current

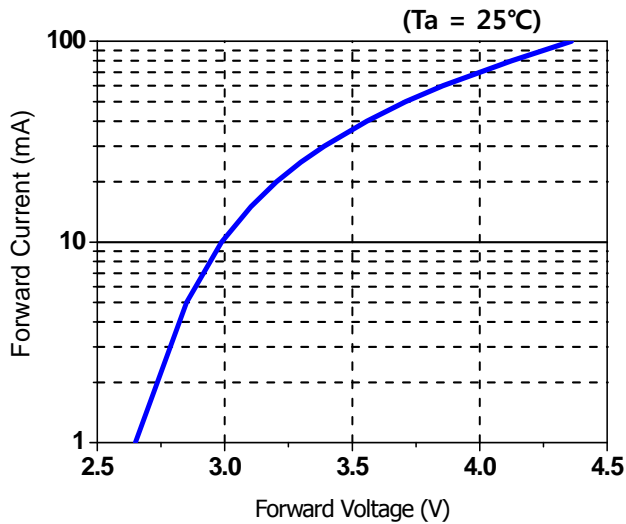

(2) Forward Current vs Relative Luminosity

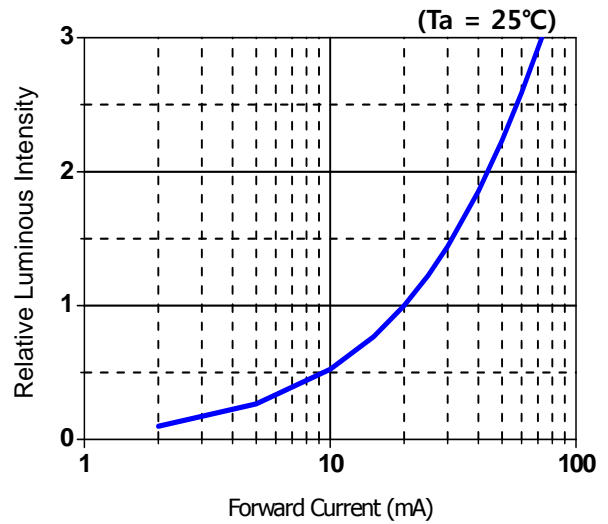

(3) Ambient Temperature vs

Allowable Forward Current

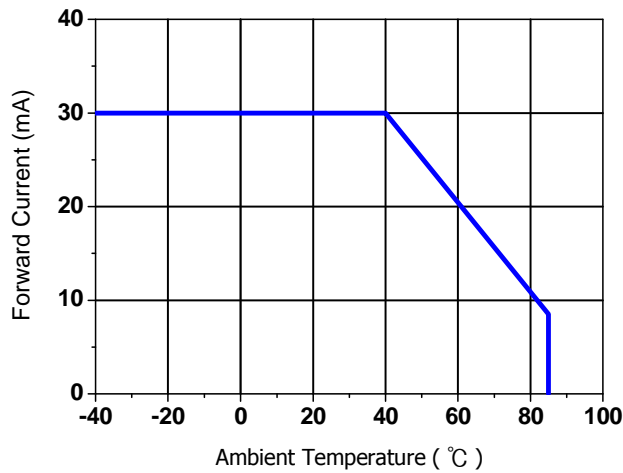

(4) Ambient Temperature vs

Relative Luminosity

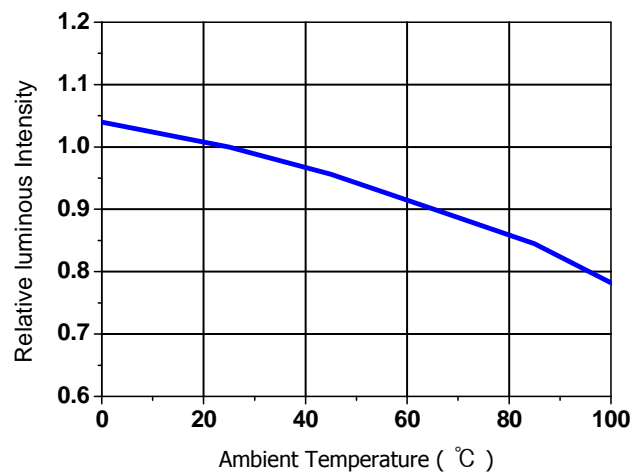

(5) View angle profile

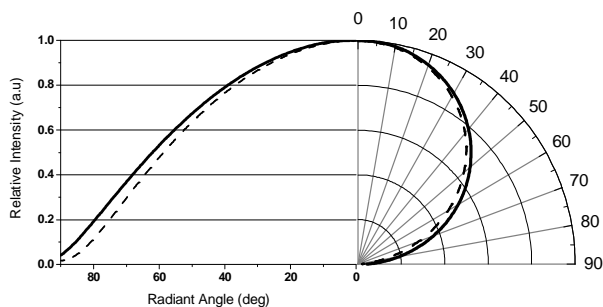

8. Reliability

(1) Test items and results

NO	Test Item	Standard Test Method	Test Conditions	Note	Number of Damaged
1	Temperature Cycle	JEITA ED-4701 100 105	-40°C~100°C 30min~30min	200 cycles	0/20
2	High Temperature Storage	JEITA ED-4701 200 201	Ta=100°C	1000 hrs	0/20
3	Temperature Humidity Storage	JEITA ED-4701 100 103	Ta=85°C, RH=85%	1000 hrs	0/20
4	Low Temperature Storage	JEITA ED-4701 200 202	Ta=-40°C	1000 hrs	0/20
5	Steady State Operating Life	-	Ta=25°C, I _F =40mA	1000 hrs	0/20
6	Steady State Operating Life of High Temperature	-	Ta=85°C, I _F =40mA	1000 hrs	0/20
7	Steady State Operating Life of High Humidity Heat	-	Ta=85°C, RH=85%, I _F =40mA	1000 hrs	0/20

8	Steady State Operating Life of Low Temperature	-	Ta=-40°C, I _F =40mA	1000 hrs	0/20
9	Electro-Static Discharge Threshold	ESD (HBM)	R1 :10MΩ,R2 :1,500Ω, 100pF (Forward)	±2,000V	0/10
			R1 :10MΩ, R2 :1,500Ω, 100pF (Reverse)	±2,000V	0/10

(2) Criteria for judging the damage

ITEM	Symbol	Test Condition	Criteria for Judgement	
			Min.	Max.
Forward Voltage	V _F	I _F = 20mA	Ini. -0.2V	Ini. +0.2V
Luminous Intensity	I _V	I _F = 20mA	Ini. x 0.7	-

11. Precautions to taken

(1) Recommend soldering conditions

Reflow Soldering		Hand Soldering(Lead Part)	
	Lead Free Solder		
Pre-heat	180~200°C	Temperature	Max. 340°C
Pre-heat time	120sec. Max.	Soldering	Max. 3sec
Peak temperature	Max. 260°C	Time	(only one time)
Soldering Time	Max. 10sec		
Condition			

Temperature-profile

<Lead-free Solder>

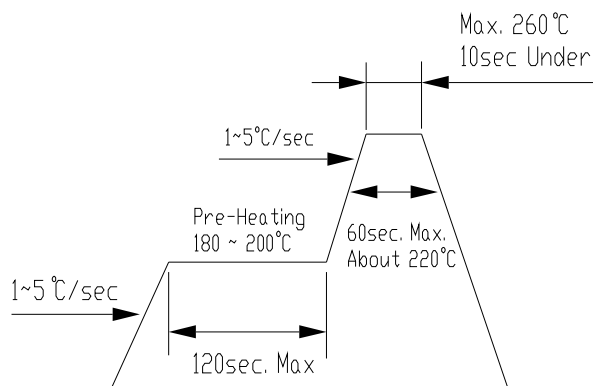

(2)Moisture Proof Package

When moisture is absorbed into the SMT package it may vaporize and expand during soldering. There is a possibility that this can cause exfoliation of the contacts and damage to the optical characteristics of the LEDs. For this reason, the moisture proof package is used to keep moisture to a minimum in the package. The moisture proof package is made of an aluminum moisture proof bag. A package of a moisture absorbent material(silica gel) is inserted into the aluminum moisture proof bag. The silica gel changes its color from blue to pink as it absorbs moisture.

(3)Storage

[Storage conditions]

Before opening the package

The LEDs should be kept at 30°C or less and 90% RH or less. The LEDs should be used within a year. When storing the LEDs, moisture proof packaging with absorbent material(silica gel) is recommended.

After opening the package

The LEDs should be kept at 30°C or less and 70% RH or less. The LEDs should be soldered within 168 hours(7days) after opening the package. If unused LEDs remain,

they should be stored in moisture proof packages, such as sealed containers with package of moisture absorbent material(silica gel). It is also recommended to return the LEDs to the original moisture proof bag and to reseal the moisture proof bag again.

If the moisture absorbent material(silica gel) has faded away or the LEDs have exceeded the storage time, baking treatment should be performed using the following conditions.

Baking treatment : more than 24hours at $65\pm 5^{\circ}\text{C}$

WOOREE E&L part's electrodes and leadframes are silver plated copper alloy. The silver surface may be affected by environments which contain corrosive substances.

Please avoid conditions which may cause the LED to corrode, tarnish or discolor. The corrosion or discoloration might lower solderability or might affect on optical Characteristics.

Please avoid rapid transitions in ambient temperature, especially in high humidity environments where condensation can occur.

(4)Heat Generation

Thermal design of the end product is of paramount importance. Please consider the heat generation of the LED when making the system design. The coefficient of temperature increase per input electric power is affected by the thermal resistance of the circuit board and density of LED placement on the board, as well as other components. It is necessary to avoid intense heat generation and operate within the maximum ratings given in the specification.

The operating current should be decided after considering the ambient maximum temperature of LEDs.

10. Packing & Label

(1) Taping part

unit : mm
Tolerance : ± 0.1

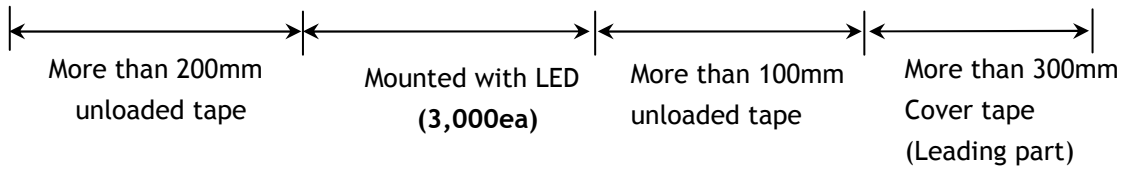
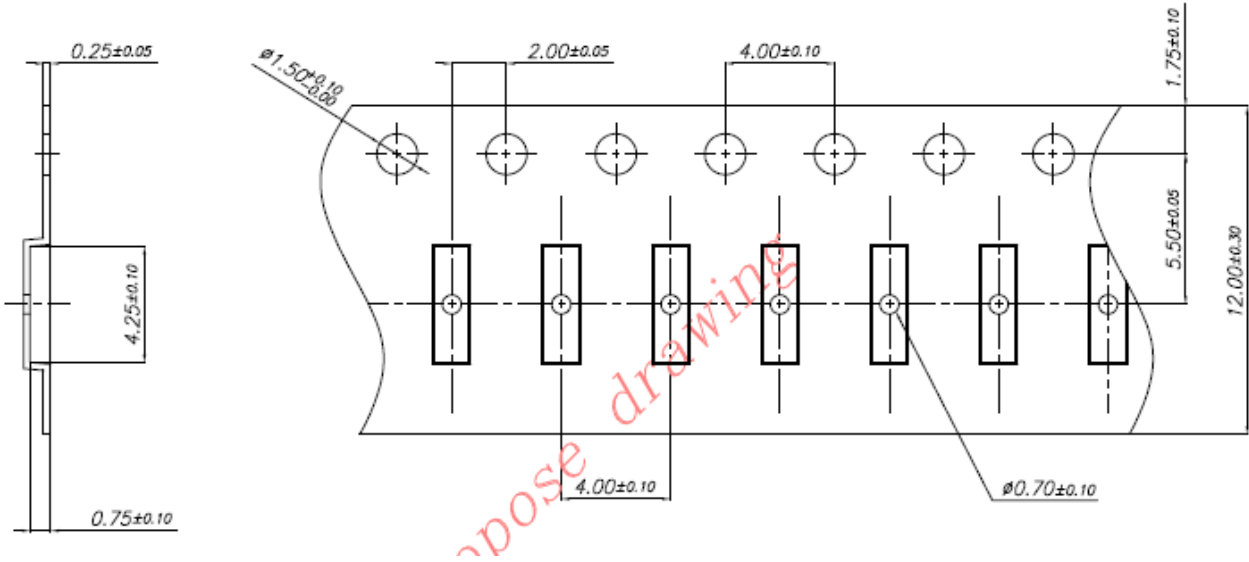

(2) Reel part (Q'ty : 3,000ea/Reel)

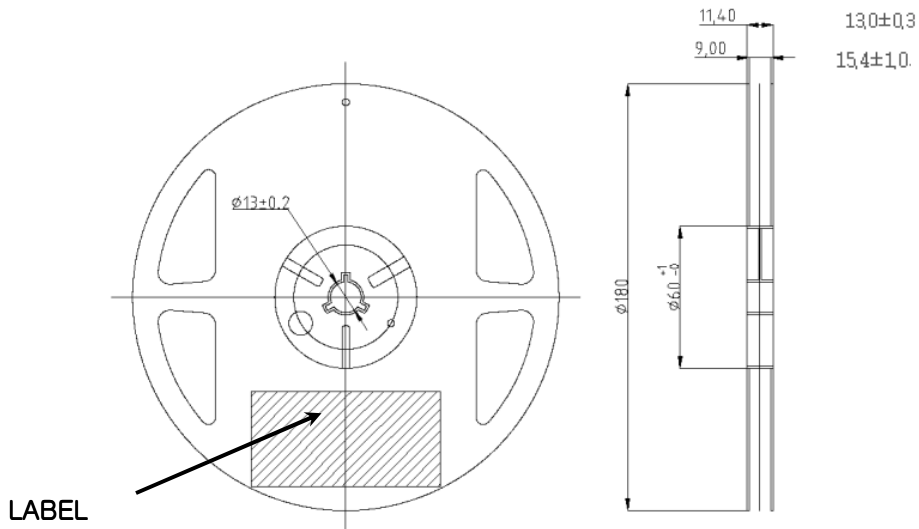

(3) Boxing

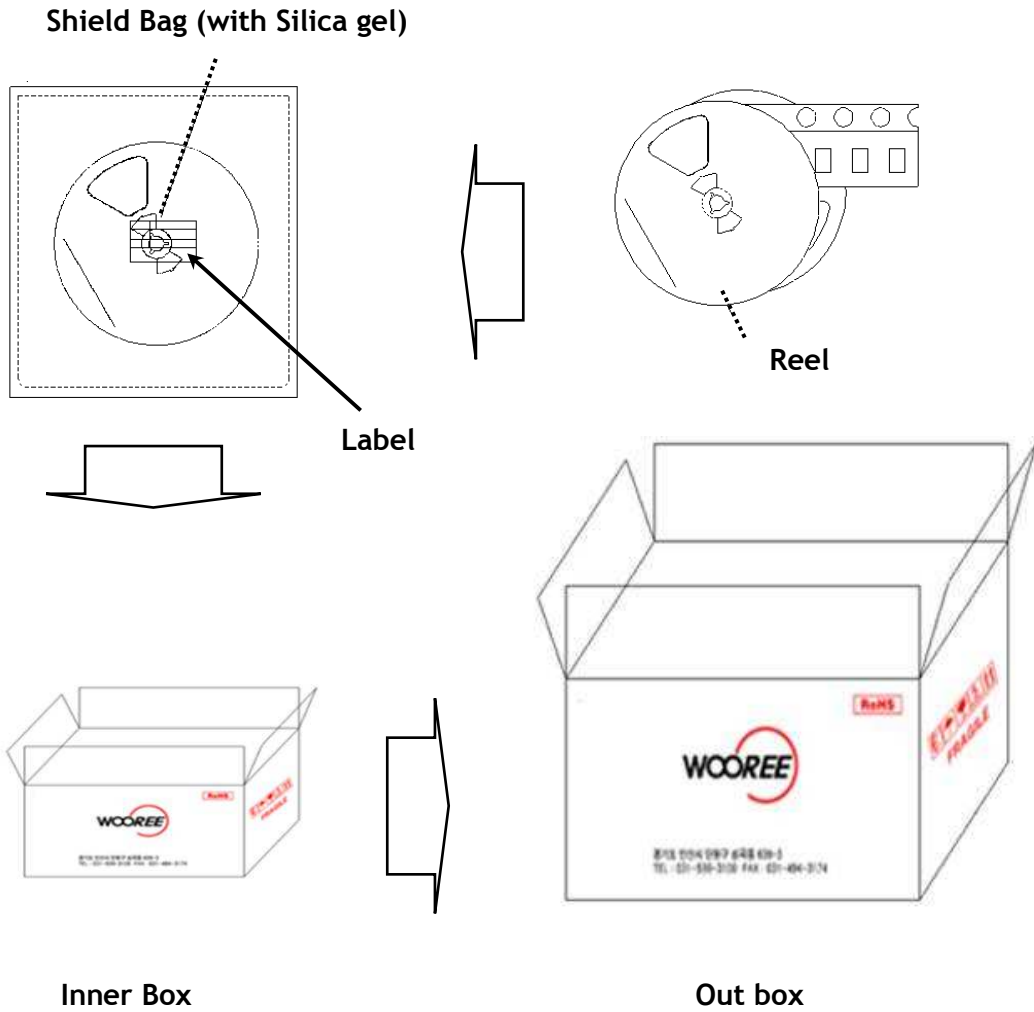

Box	Dimension (mm)	Reel/Box	Quantity/Box
Inner box	500*260*250	30 Reel max.	90,000 ea
Out box	555*515*540	120 Reel max.	360,000 ea

(4) Label Information



(5) Lot Number



- ① WOOREE E&L Initial
- ② Year (13 for 2013, 14 for 2014)
- ③ Month (A for Jan., B for Feb., ... , M for Dec.)
- ④ Day (01 for 1,...31 for 31)
- ⑤ WOOREE E&L Product Running Number

(6) Rank Code description

