

Data Sheet for Product

Part Number : WM82T2F-YR07B-S



The Component corresponds with display's hazardous substance management standard and complies with RoHS and Halogen free.

WOOREE E&L Co.,Ltd.

636-3, Sunggok-dong, Danwon-gu, Ansan-si, Kyunggy-do, Korea. Tel (031)599-3013 Fax (031)494-3174

CONTENTS

- 1. Features**
- 2. Outline Dimension**
- 3. Material Information**
- 4. Absolute Maximum Ratings**
- 5. Electrical / Optical Characteristics**
- 6. Rank Information**
- 7. Characteristic Diagrams**
- 8. Reliability**
- 9. Soldering Information**
- 10. Packaging & Label**

1. Features

- SMD Top View Type with Lead Frame Base
- Long Time Reliability
- Package size is 8.5 * 2.0* 0.8t (mm), 2Lead
- Application : TV BLU

2. Outline Dimension

UNIT : mm

Tolerance : ± 0.05

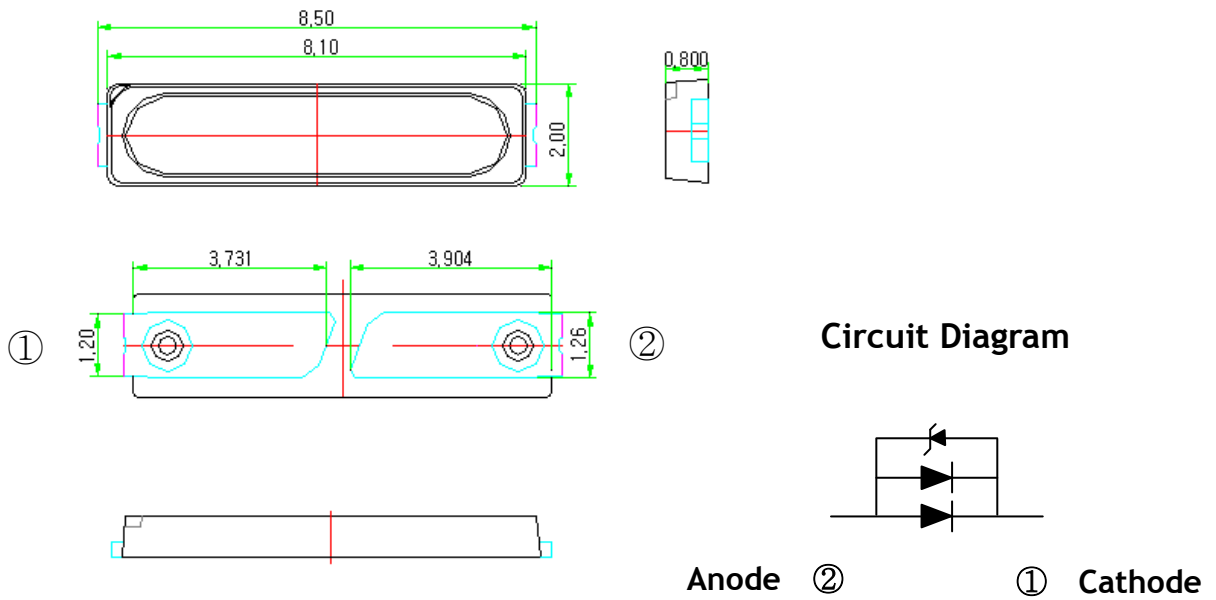

3. Material Information

| Item | Chip | | Paste | | Leadframe | | Phosphor | Encap | Wire |
|----------|-------|-------|----------------|-------------|-----------|------------------|----------|----------|------|
| | LED | Zener | LED | Zener | Reflector | Metal | | | |
| Material | InGaN | Si | Clear Paste | Ag Paste | PCT | Ag plated /Cu | Nitride | Silicone | Au |

4. Absolute maximum ratings

(Ta=25°C)

| Item | Symbol | Absolute Maximum Ratings | Unit |
|--------------------------|-------------------|---|------|
| Forward Current | IF | 200 | mA |
| Power Dissipation | PD | 0.5 | W |
| Reverse Current | IR | 50 | mA |
| Pulse Forward Current *1 | I _{FP*1} | 280 | mA |
| Operating Temperature | Topr | -40 ~ +85 | °C |
| Storage Temperature | Tstg | -40 ~ +100 | °C |
| Solder Temperature | Tsld | Reflow 260 °C,10sec under Hand 340 °C 3sec under | °C |
| Junction Temperature | Tj | 115 | °C |

*1. Pulse Width ≤ 10msec, Duty ≤ 10%

5. Electrical/Optical characteristics

(Ta=25°C)

| Item | Symbol | Condition | Value | | | Unit | |
|--|---------|--------------|-------|-------|-------|-------|---|
| | | | Min | Typ | Max | | |
| Luminous Intensity ^{*1} | Iv | IF=130mA | 11.5 | 12.8 | - | cd | |
| Forward Voltage ^{*2} | VF | IF=130mA | 2.9 | 3.2 | 3.4 | V | |
| Forward Voltage | VFL | IF=1uA | 2.0 | | 2.5 | | |
| Forward Voltage | VFL | IF=10uA | 2.2 | - | 2.55 | V | |
| Chromaticity | - | IF=130mA | x | 0.243 | 0.261 | 0.279 | - |
| Coordinate ^{*3} | | | y | 0.193 | 0.217 | 0.241 | - |
| Reverse Voltage | VR | IR=-5mA | -0.7 | | -1.2 | V | |
| Viewing Angle | 2Θ1/2 | IF=130mA | - | 120 | - | Deg. | |
| Thermal Resistance (Junction to Lead) | Rth,j-s | IF=130mA | | 14 | | K/W | |
| Life Time ^{*4} | - | Tj max. 85°C | 30K | 50K | - | hr | |
| ESD | - | - | 5 | - | - | KV | |
| Peak Wavelength | Wp | - | 435.5 | | 451.5 | nm | |

*1. Luminous Intensity(Flux) measurement allowance is ±10%

*2. Forward voltage measurement : ±0.1V

*3. CIE coordinates measurement: ±0.005

*4. Estimated Time to 50% degradation for initial luminous intensity based on WOOREE LED's Internal test results.

※Life time : * Min 산출 방법 : L50B1 , * Typ 산출 : MTTF

6. Ranks

(1) Luminous Intensity

| Code | Condition | Min. | Max. | Unit |
|------|------------|------|------|------|
| B5 | IF = 130mA | 11.5 | 12.0 | cd |
| C0 | | 12.0 | 12.5 | |
| C5 | | 12.5 | 13.0 | |
| D0 | | 13.0 | 13.5 | |
| D5 | | 13.5 | 14.0 | |
| E0 | | 14.0 | 14.5 | |
| E5 | | 14.5 | 15.0 | |
| F0 | | 15.0 | 15.5 | |

(2) Forward Voltage

| Code | Condition | Min. | Max. | Unit |
|------|------------|------|------|------|
| 9 | IF = 130mA | 2.9 | 3.1 | V |
| 1 | | 3.1 | 3.3 | |
| 3 | | 3.3 | 3.4 | |

(3) Peak Wavelength

| Code | Condition | Min. | Max. | Unit |
|------|------------|-------|-------|------|
| A | IF = 130mA | 435.5 | 440.5 | nm |
| B | | 440.5 | 446.5 | |
| C | | 446.5 | 451.5 | |

(4) Chromaticity Coordinates Diagram

IF=130mA (Ta = 25°C)

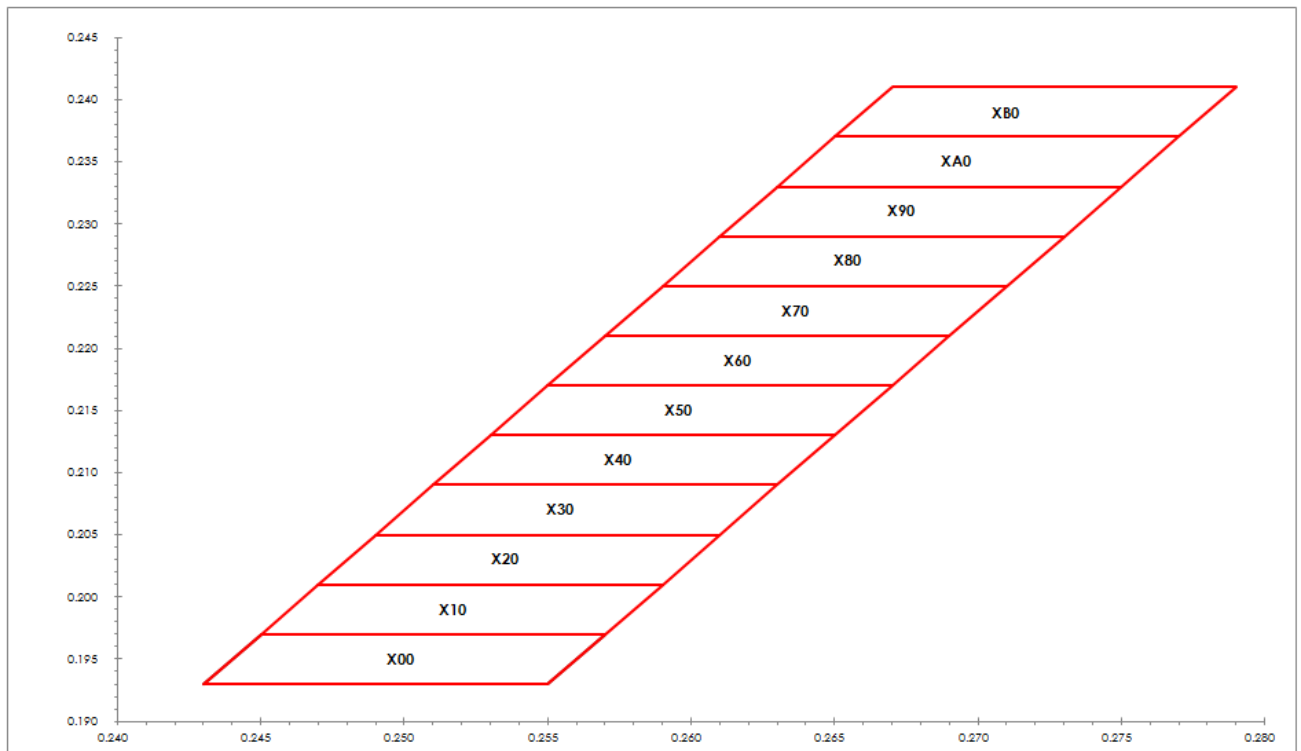

(5) Color spectrum

IF=130mA (Ta = 25°C)

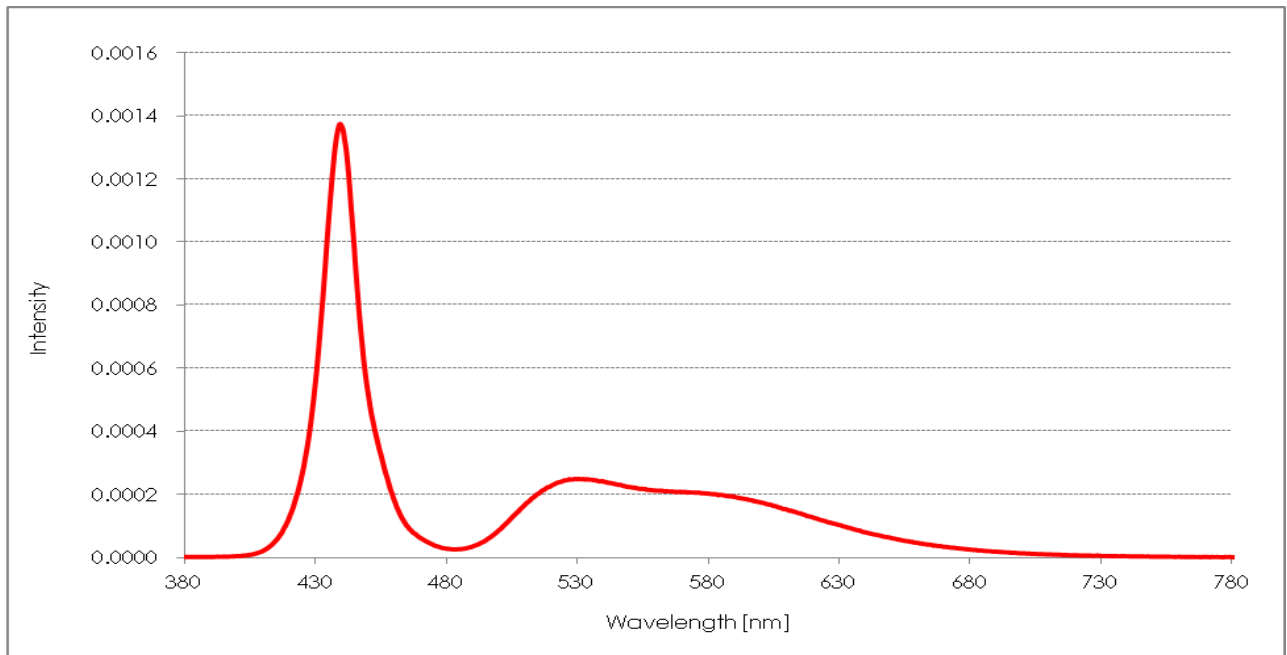

7. Characteristic Diagrams

(1) Forward Voltage vs Forward Current

(Ta = 25°C)

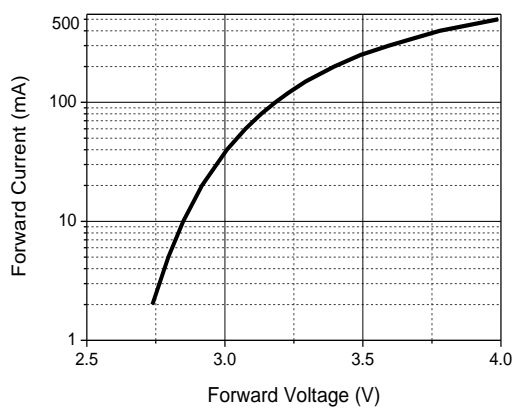

(2) Forward Current vs Relative Luminosity

(Ta = 25°C)

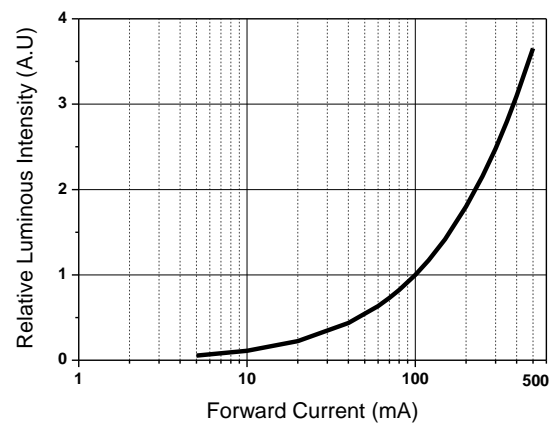

(3) Ambient Temperature vs

Allowable Forward Current

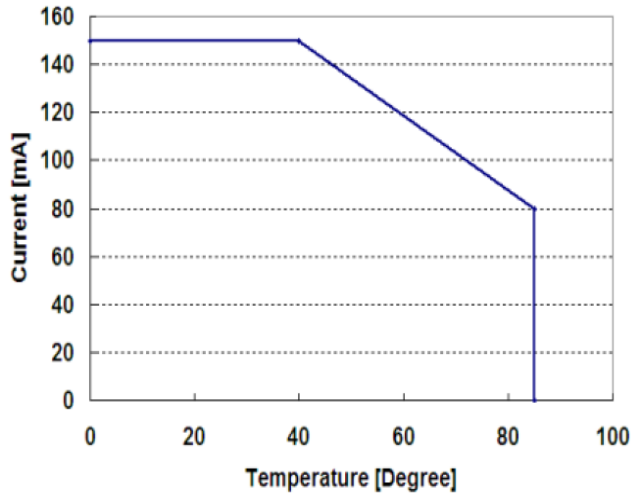

(4) Ambient Temperature vs

Relative Luminous Flux

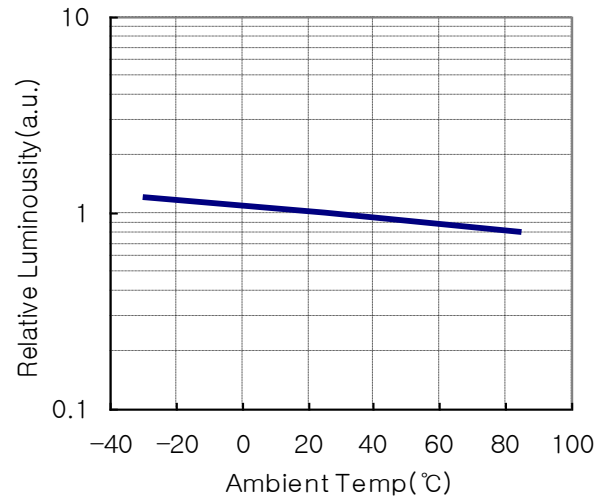

(5) Forward Current vs Chromaticity coordinate

(Ta = 25°C)

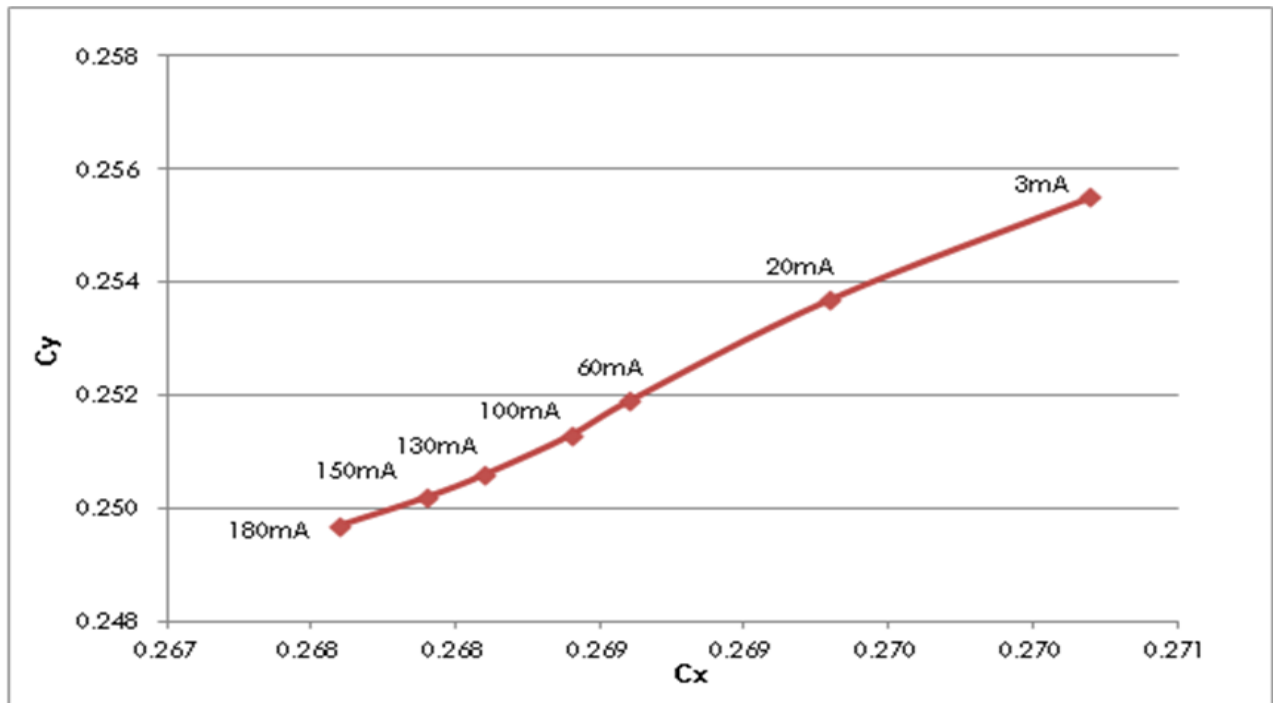

(6) View angle profile

IF= 130mA

(Temp: 25°C)

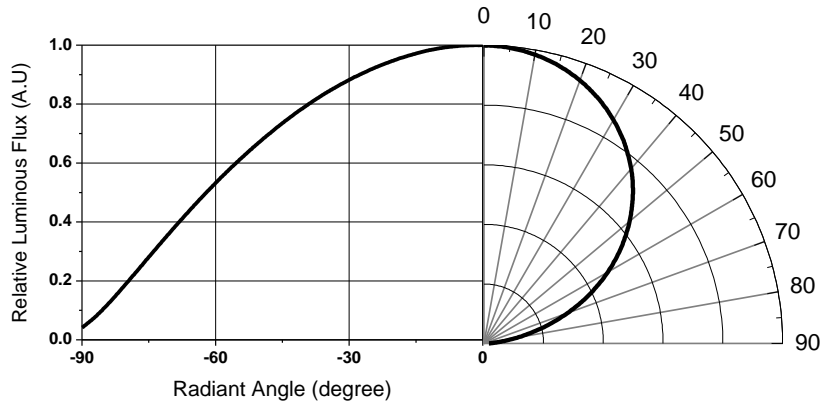

8. Reliability

(1) Test items and results

| NO | Test Item | Standard Test Method | Test Conditions | Note | Number of Damaged |
|----|--|--------------------------|--|------------------------|-------------------|
| 1 | Resistance to Soldering Heat (Reflow Soldering) | JEITA ED-4701 300 301 | Tsld=260°C, 10sec. (Pre treatment 30°C,70%,168hrs) | 2 times | 0/20 |
| 2 | Solderability (Reflow Soldering) | JEITA ED-4701 300 303 | Tsld=245±5°C, 3sec (Lead Solder) | 1 time over 95% | 0/20 |
| 3 | Temperature Cycle | JEITA ED-4701 100 105 | -45°C - 125°C 15min – 15min Trans time : 3min | 310 cycles | 0/20 |
| 4 | Temperature Cycle | JEITA ED-4701 100 105 | -40°C - 100°C 30min - 30min Trans time : 3min | 200 cycles | 0/20 |
| 5 | High Temperature Storage | JEITA ED-4701 200 201 | Ta=100°C | 1000 hrs | 0/20 |
| 6 | Temperature Humidity Storage | JEITA ED-4701 100 103 | Ta=85°C, RH=85% | 1000 hrs | 0/20 |
| 7 | Low Temperature Storage | JEITA ED-4701 200 202 | Ta=-40°C | 1000 hrs | 0/20 |

| | | | | | |
|----|---|--------------|---|------------|------|
| 8 | Steady State Operating Life | - | Ta=25°C, IF=162.5mA | 1000 hrs | 0/20 |
| 9 | Steady State Operating Life of High Temperature | - | Ta=60°C, IF=162.5mA | 1000 hrs | 0/20 |
| 10 | Steady State Operating Life of High Temperature | - | Ta=85°C, IF=162.5mA | 1000 hrs | 0/20 |
| 11 | Steady State Operating Life of High Humidity Heat | - | Ta=85°C, RH=85%, IF=162.5mA | 1000 hrs | 0/20 |
| 12 | Steady State Operating Life of Low Temperature | - | Ta=-40°C, IF=162.5mA | 1000 hrs | 0/20 |
| 13 | On-Off Operating Test | - | 50°C, 95%RH, IF=162.5mA, On/Off each 2sec | 100K Cycle | 0/10 |
| 14 | Electro-Static Discharge Threshold | ESD (HBM) | 1500Ω, 100pF (Forward/Reverse) | 6000V | 0/20 |

(2) Criteria for judging the damage

| ITEM | Symbol | Test Condition | Criteria for Judgement | |
|-----------------|--------|----------------|------------------------|------------------|
| | | | Min. | Max. |
| Forward Voltage | VF | IF = 162.5mA | - | U.S.L. *1) × 1.1 |
| Luminous Flux | Φv | IF = 162.5mA | L.S.L*2)× 0.7 | - |

*1) U.S.L. : Upper Standard Level

*2) L.S.L : Lower Standard Level

(3) Silicone Depth Judgement

Silicone Depth Spec

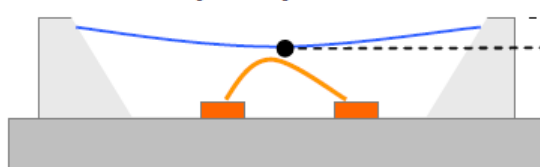

- Silicone Depth = A ~ B
- A : Mold 상단면
- B : 봉지재 면 (PKG 중심부)

• LED PKG Silicone Depth Spec.

1. 상온 (25°C)에서 Silicone Depth > 30um 일 것
2. Wire는 봉지재 위로 노출 없을 것

Silicone Depth Spec 불량

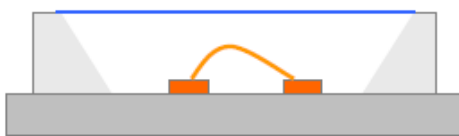

- LED PKG Silicone Depth = 0 um (Flat) 으로 불량 임.

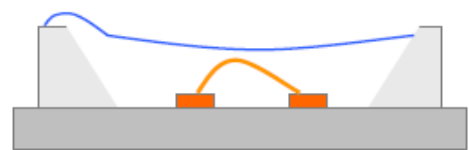

- 봉지재가 Mold 상단면을 넘침으로 불량 임.

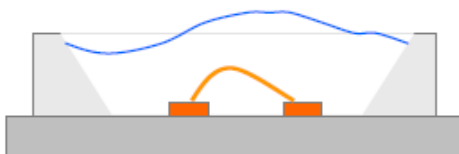

- 봉지재의 중심 또는 일부가 Mold 상단면 보다 돌출 되므로 불량 임.

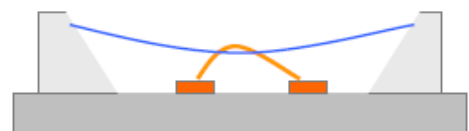

- Wire가 봉지재 위로 노출되어 불량 임.

9. Precautions to taken

Recommend soldering conditions

| Reflow Soldering | | | Hand Soldering(Lead Part) | |
|------------------|--------------------------|--------------------------|----------------------------|--|
| Pre-heat | Lead Solder | Lead Free Solder | Temperature Soldering Time | Max. 340°C Max. 3sec (only one time) |
| Pre-heat time | | | | |
| Peak temperature | 120~150°C | 180~200°C | | |
| Soldering Time | 120sec | 120sec. Max. | | |
| Condition | Max. 240°C Max. 10sec | Max. 260°C Max. 10sec | | |

Temperature-profile

<Lead Solder>

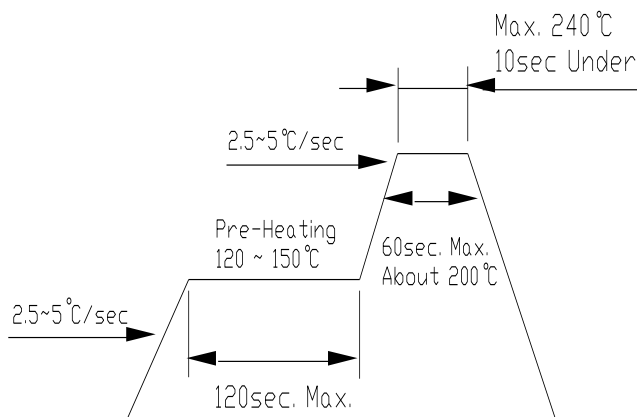

<Lead-free Solder>

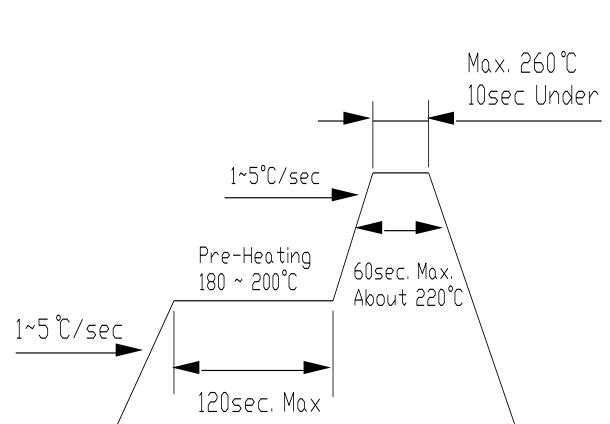

<Recommended soldering pad design>

Unit: mm

Solder Land

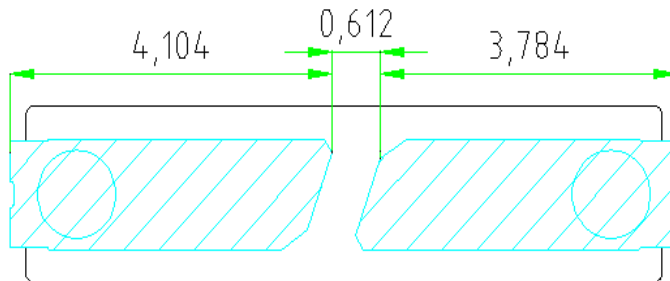

(2) Moisture Proof Package

When moisture is absorbed into the SMT package it may vaporize and expand during soldering. There is a possibility that this can cause exfoliation of the contacts and damage to the optical characteristics of the LEDs. For this reason, the moisture proof package is used to keep moisture to a minimum in the package. The moisture proof package is made of an aluminum moisture proof bag. A package

of a moisture absorbent material(silica gel) is inserted into the aluminum moisture proof bag. The silica gel changes its color from blue to pink as it absorbs moisture.

(3) Storage

[Storage conditions]

Before opening the package

The LEDs should be kept at 30°C or less and 90% RH or less. The LEDs should be used within a year. When storing the LEDs, moisture proof packaging with absorbent material(silica gel) is recommended.

After opening the package

The LEDs should be kept at 30°C or less and 70% RH or less. The LEDs should be soldered within 168 hours(7days) after opening the package. If unused LEDs remain,

they should be stored in moisture proof packages, such as sealed containers with package of moisture absorbent material(silica gel). It is also recommended to return the LEDs to the original moisture proof bag and to reseal the moisture proof bag again.

If the moisture absorbent material(silica gel) has faded away or the LEDs have exceeded the storage time, baking treatment should be performed using the following conditions.

Baking treatment : more than 24hours at $65\pm 5^{\circ}\text{C}$

WOOREE E&L part's electrodes and leadframes are silver plated copper alloy.

The silver surface may be affected by environments which contain corrosive substances.

Please avoid conditions which may cause the LED to corrode, tarnish or discolor.

The corrosion or discoloration might lower solderability or might affect on optical Characteristics.

Please avoid rapid transitions in ambient temperature, especially in high humidity environments where condensation can occur.

(4) Heat Generation

Thermal design of the end product is of paramount importance. Please consider the heat generation of the LED when making the system design. The coefficient of temperature increase per input electric power is affected by the thermal resistance of the circuit board and density of LED placement on the board, as well as other components. It is necessary to avoid intense heat generation and operate within the maximum ratings given in the specification.

The operating current should be decided after considering the ambient maximum temperature of LEDs.

(5) Handling Precautions

When handling the product, touching encapsulant with bare hands will contaminate its surface that could affect optical characteristics. In the worst cases, excessive force to the encapsulant by hand might result in catastrophic failure of the LEDs due to wire deformation and/or breakage.

10. Packing & Label

(1) Taping part

unit : mm
tolerance : ± 0.1

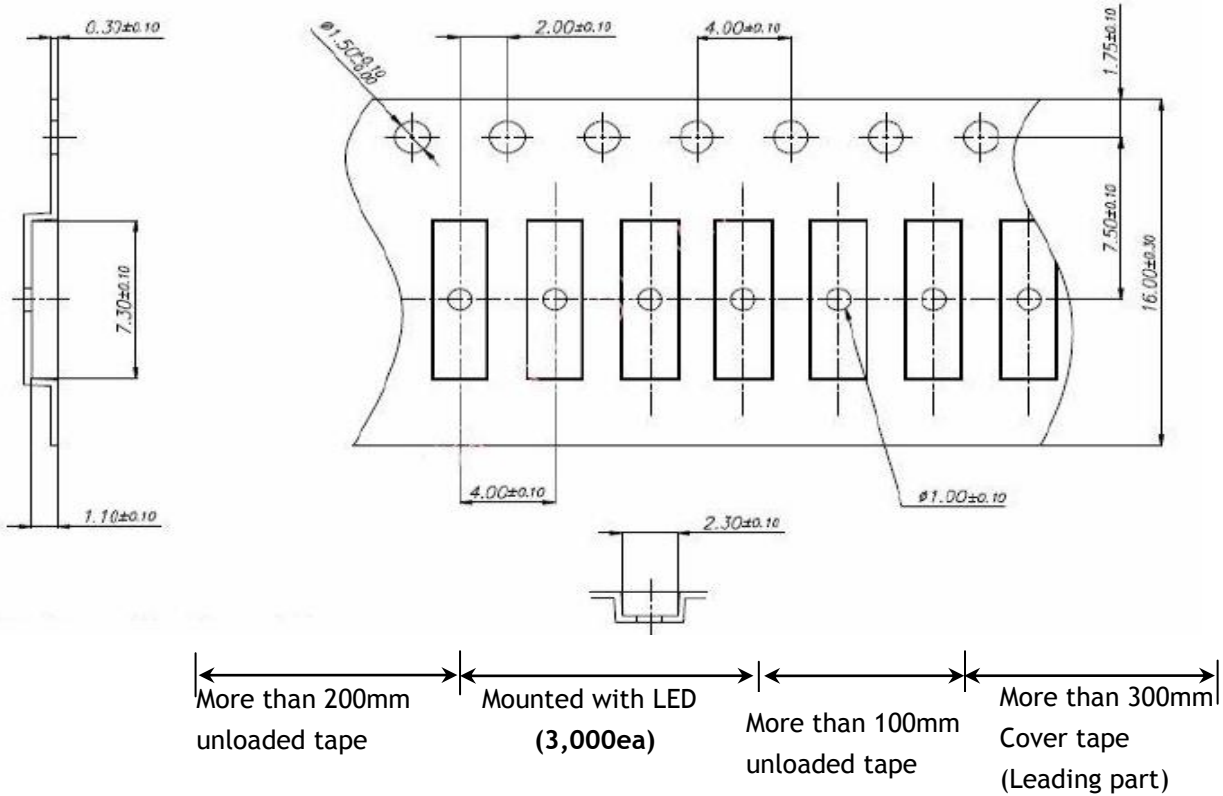

(2) Reel part (Q'ty : 3,000ea/Reel)

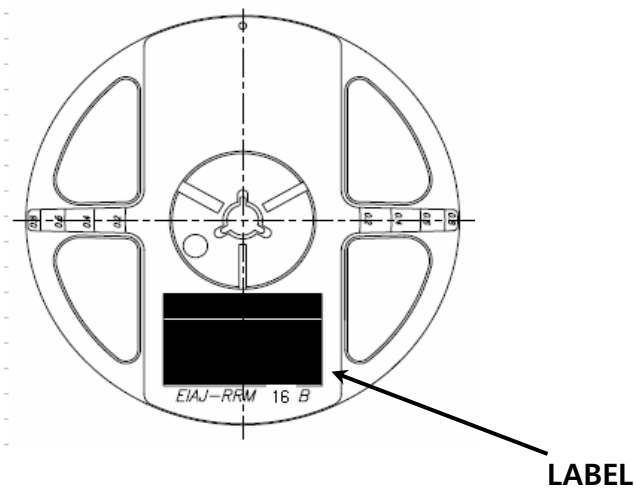

(3) Boxing

Shield Bag (with Silica gel)

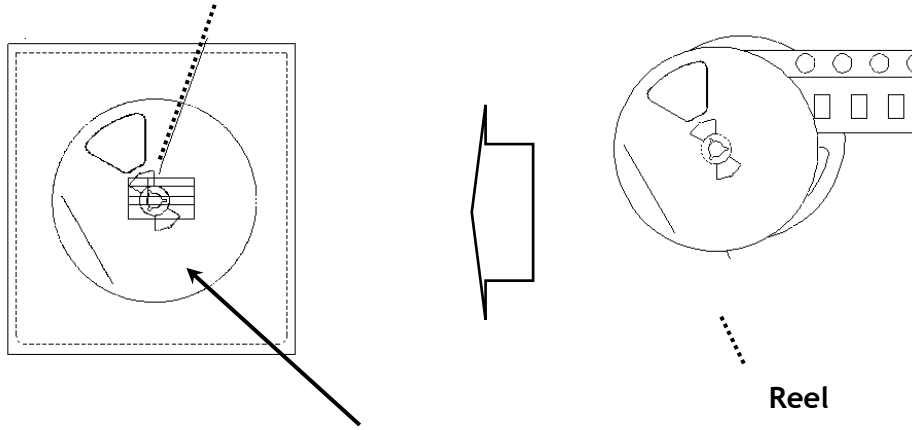

Label



Inner Box

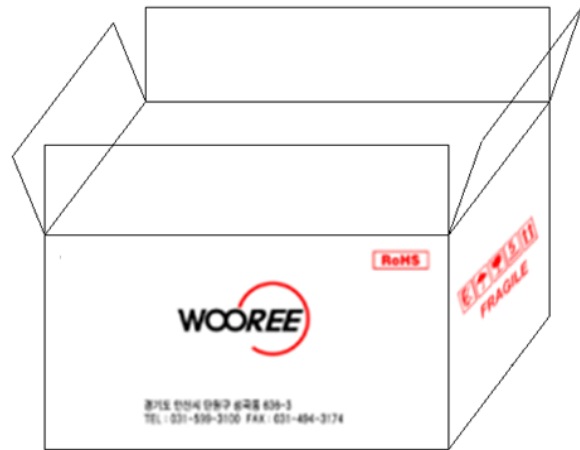

Out box

| Box | Dimension (mm) | Reel/Box | Quantity/Box |
|-----------|-----------------|--------------|--------------|
| Inner box | 220 x 125 x 261 | 10 Reel max. | 60,000 ea |
| Out box | 383 x 228 x 267 | 30 Reel max. | 90,000 ea |

(4) Label Information

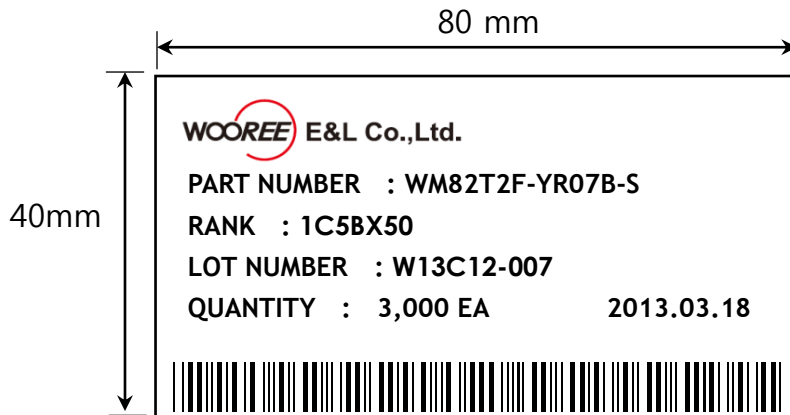

(5) Lot Number

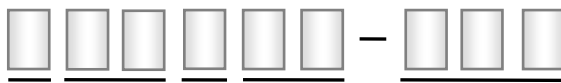

① ② ③ ④ ⑤

- ① WOOREE LED Initial
- ② Year (13 for 2013, 14 for 2014)
- ③ Month (A for Jan., B for Feb., ... , N for Dec.)
- ④ Day (01 for 1,....31 for 31)
- ⑤ WOOREE LED Product Running Number

(6) Rank Code description

