

Customer :

Specification for Approval

Part Name : **WL82T2F-xx70B**

(Preliminary)

Customer : _____ 2014. . . .

Checked	Checked	Approved	Remark
/	/	/	

WOOREE E&L Co., Ltd. _____ 2014. 05. 21.

Designed	Checked	Checked	Approved
/	/	/	/

WOOREE E&L CO., LTD 636-3, Sunggok-dong, Danwon-gu, Ansan-si, Kyunggy-do, Korea.

Tel (031)599-3013 Fax (031)494-3174

 **WOOREE** E&L Co.,Ltd.

CONTENTS

1. Features
2. Outline Dimension
3. Absolute Maximum Ratings
4. Electrical / Optical Characteristics
5. Ranks
6. Color Spectrum
7. Characteristic Diagrams
8. Reliability
9. Recommend soldering conditions
10. Packing
11. Revision History

1. Features

- SMD Top View Type
- Long Time Reliability
- Package size is 8.5 * 2.0* 0.8t (mm), 2Lead
- Application : Advertising / Signage Back Light / Corporate Identity
Architectural Lighting source

2. Outline Dimension

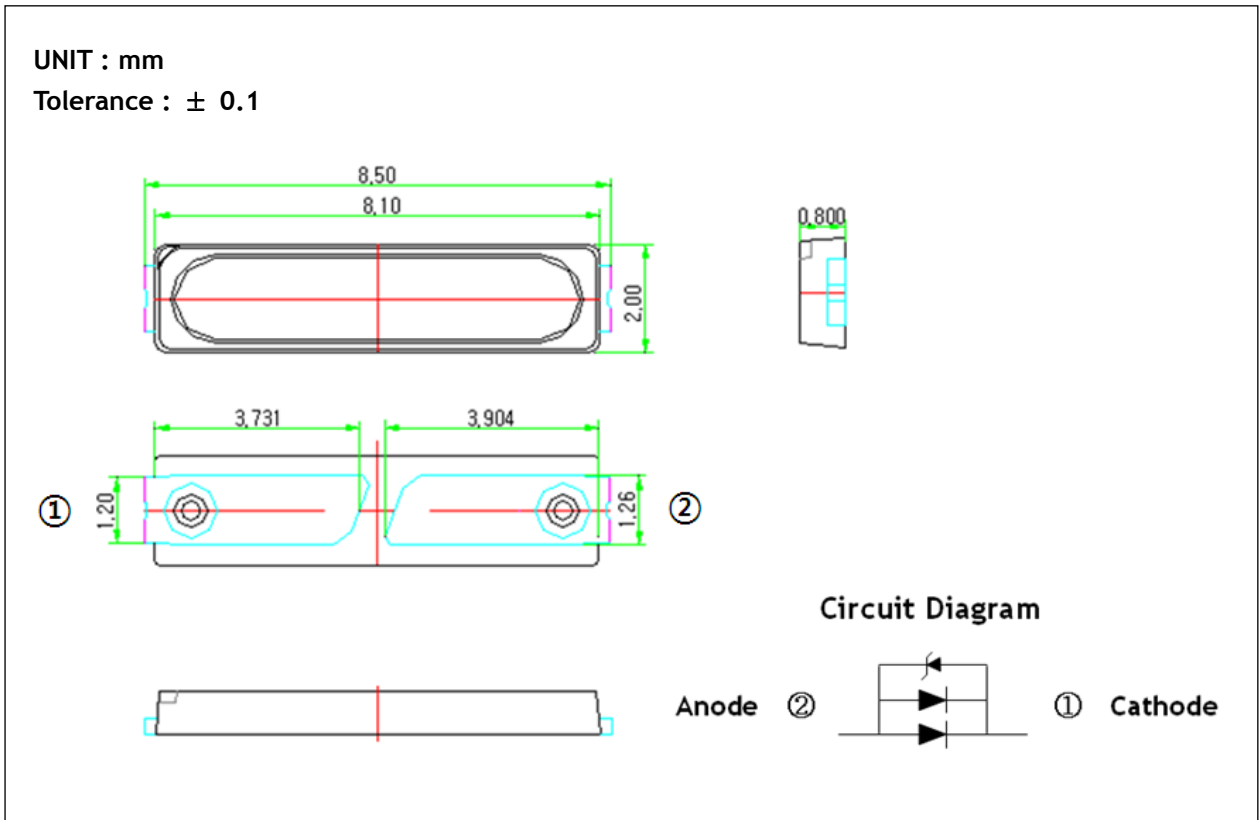

Part list

Parts No.	Name	Description	Materials
1	Chip source	Blue LED	InGaN / Sapphire
2	Body	Thermo Plastic	PCT
3	Lead frame base	Metal	Copper alloy
4	Phosphor	Yellow, Orange, R.G color Emitting	Aluminate / Nitride
5	Resin	Encapsulant	Silicone

3. Absolute maximum ratings

Item	Symbol	Absolute Maximum Ratings	Unit
Forward Current	I_F	75	mA
Power Dissipation	P_D	0.27	W
Pulse Forward Current	I_{FP*1}	200	mA
Operating Temperature	T_{opr}	-30 ~ +85	°C
Storage Temperature	T_{stg}	-40 ~ +100	°C
Solder Temperature	T_{sld}	Reflow 260 °C 10sec under Hand 340 °C 3sec under	°C
Junction Temperature	T_J	110	°C

*1. Pulse Width ≤ 10msec, Duty ≤ 10%

4. Electrical/Optical characteristics

($T_a=25^\circ\text{C}$)

Item	Symbol	Condition	Value			Unit
			Min	Typ.	Max	
Forward Voltage ¹⁾	V_F	$I_F=65\text{mA}$	3.25	-	3.55	V
Luminous Intensity ²⁾	I_v	$I_F=65\text{mA}$	8.0	-	9.0	cd
Luminous Flux	Φ_v	$I_F=65\text{mA}$	25.1	-	30.2	lm
Color Temperature ³⁾ [CIE 1931 Coordinates]	CCT	$I_F=65\text{mA}$	4745	-	7690	K
Reverse Voltage	V_R	$I_R=5\text{mA}$	0.7	-	1.2	V
Viewing Angle	$2\theta_{1/2}$	$I_F=65\text{mA}$	-	120	-	Deg.
Color Rendering Index	R_a	$I_F=65\text{mA}$	70	-	-	-
Thermal Resistance	R_{TH}	-	-	21.0	-	°C/W

1) Forward voltage measurement allowance is ±0.1V

2) Luminous Flux measurement allowance is ±5%

3) CIE coordinates measurement: ±0.005

5. Ranks

(1) Forward Voltage

(Ta=25℃)

Rank	Condition	Min.	Max.	Unit
2	I _F = 65mA	3.25	3.35	V
3		3.35	3.45	
4		3.45	3.55	

(2) Luminous Intensity (Flux)

(Ta=25℃)

Rank	Range [cd]	Condition	6500K	5700K	5000K	Unit
750	7.5-8.0	I _F = 65mA	25.1-26.8	-	-	lm
800	8.0-8.5		26.8-28.5	26.8-28.5	26.8-28.5	
850	8.5-9.0		-	28.5-30.2	28.5-30.2	

* Luminous Intensity Measuring condition is 0.01sr (CIE1931, LED Condition B)

(3) Chromaticity coordinates

(I_F= 65mA, Ta=25℃)

5000K (CCT 5155 - 5311K)

50A		50B		50C		50D		50E	
x	y	x	y	x	y	x	y	x	y
0.3363	0.3307	0.3366	0.3369	0.3369	0.3431	0.3374	0.3554	0.3376	0.3616
0.3366	0.3369	0.3369	0.3431	0.3374	0.3554	0.3376	0.3616	0.3379	0.3678
0.3403	0.3398	0.3407	0.3462	0.3416	0.3589	0.3420	0.3652	0.3424	0.3716
0.3399	0.3335	0.3403	0.3398	0.3407	0.3462	0.3416	0.3589	0.3420	0.3652

5000K (CCT 5010 - 5155K)

50F		50G		50H		50J		50K	
x	y	x	y	x	y	x	y	x	y
0.3399	0.3335	0.3403	0.3398	0.3407	0.3462	0.3416	0.3589	0.3420	0.3652
0.3403	0.3398	0.3407	0.3462	0.3416	0.3589	0.3420	0.3652	0.3424	0.3716
0.3441	0.3428	0.3446	0.3493	0.3458	0.3623	0.3463	0.3688	0.3469	0.3753
0.3435	0.3363	0.3441	0.3428	0.3446	0.3493	0.3458	0.3623	0.3463	0.3688

5000K (CCT 4874 - 5010K)

50L		50M		50N		50O		50P	
x	y	x	y	x	y	x	y	x	y
0.3435	0.3363	0.3441	0.3428	0.3446	0.3493	0.3458	0.3623	0.3463	0.3688
0.3441	0.3428	0.3446	0.3493	0.3458	0.3623	0.3463	0.3688	0.3469	0.3753
0.3478	0.3457	0.3485	0.3524	0.3500	0.3658	0.3508	0.3724	0.3515	0.3791
0.3470	0.3391	0.3478	0.3457	0.3485	0.3524	0.3500	0.3658	0.3508	0.3724

5000K (CCT 4745 - 4874K)

50Q		50R		50S		50T		50U	
x	y	x	y	x	y	x	y	x	y
0.3470	0.3391	0.3478	0.3457	0.3485	0.3524	0.3500	0.3658	0.3508	0.3724
0.3478	0.3457	0.3485	0.3524	0.3500	0.3658	0.3508	0.3724	0.3515	0.3791
0.3515	0.3487	0.3524	0.3555	0.3542	0.3692	0.3551	0.3760	0.3560	0.3828
0.3506	0.3419	0.3515	0.3487	0.3524	0.3555	0.3542	0.3692	0.3551	0.3760

5700K (CCT 5823 - 6020K)

57A		57B		57C		57D		57E	
x	y	x	y	x	y	x	y	x	y
0.3226	0.3192	0.3222	0.3247	0.3218	0.3302	0.3210	0.3412	0.3206	0.3467
0.3222	0.3247	0.3218	0.3302	0.3210	0.3412	0.3206	0.3467	0.3202	0.3522
0.3258	0.3276	0.3256	0.3334	0.3251	0.3446	0.3249	0.3503	0.3247	0.3560
0.3260	0.3220	0.3258	0.3276	0.3256	0.3334	0.3251	0.3446	0.3249	0.3503

5700K (CCT 5641 ~ 5823K)

57F		57G		57H		57J		57K	
x	y	x	y	x	y	x	y	x	y
0.3260	0.3220	0.3258	0.3276	0.3256	0.3334	0.3251	0.3446	0.3249	0.3503
0.3258	0.3276	0.3256	0.3334	0.3251	0.3446	0.3249	0.3503	0.3247	0.3560
0.3294	0.3307	0.3293	0.3364	0.3292	0.3482	0.3292	0.3540	0.3291	0.3599
0.3294	0.3248	0.3294	0.3307	0.3293	0.3364	0.3292	0.3482	0.3292	0.3540

5700K (CCT 5468 ~ 5641K)

57L		57M		57N		57O		57P	
x	y	x	y	x	y	x	y	x	y
0.3294	0.3248	0.3294	0.3307	0.3293	0.3364	0.3292	0.3482	0.3292	0.3540
0.3294	0.3307	0.3293	0.3364	0.3292	0.3482	0.3292	0.3540	0.3291	0.3599
0.3330	0.3337	0.3331	0.3398	0.3333	0.3518	0.3334	0.3578	0.3335	0.3638
0.3329	0.3277	0.3330	0.3337	0.3331	0.3398	0.3333	0.3518	0.3334	0.3578

5700K (CCT 5311 ~ 5468K)

57Q		57R		57S		57T		57U	
x	y	x	y	x	y	x	y	x	y
0.3329	0.3277	0.3330	0.3337	0.3331	0.3398	0.3333	0.3518	0.3334	0.3578
0.3330	0.3337	0.3331	0.3398	0.3333	0.3518	0.3334	0.3578	0.3335	0.3638
0.3366	0.3369	0.3369	0.3431	0.3374	0.3554	0.3376	0.3616	0.3379	0.3678
0.3363	0.3307	0.3366	0.3369	0.3369	0.3431	0.3374	0.3554	0.3376	0.3616

6500K (CCT 6749 ~ 7040K)

65A		65B		65C		65D		65E	
x	y	x	y	x	y	x	y	x	y
0.3078	0.3066	0.3068	0.3113	0.3058	0.3160	0.3038	0.3256	0.3028	0.3304
0.3068	0.3113	0.3058	0.3160	0.3038	0.3256	0.3028	0.3304	0.3018	0.3351
0.3106	0.3150	0.3098	0.3199	0.3081	0.3299	0.3072	0.3348	0.3064	0.3397
0.3115	0.3101	0.3106	0.3150	0.3098	0.3199	0.3081	0.3299	0.3072	0.3348

6500K (CCT 6485 ~ 6749K)

65F		65G		65H		65J		65K	
x	y	x	y	x	y	x	y	x	y
0.3115	0.3101	0.3106	0.3150	0.3098	0.3199	0.3081	0.3299	0.3072	0.3348
0.3106	0.3150	0.3098	0.3199	0.3081	0.3299	0.3072	0.3348	0.3064	0.3397
0.3145	0.3187	0.3138	0.3238	0.3123	0.3341	0.3116	0.3393	0.3109	0.3444
0.3152	0.3136	0.3145	0.3187	0.3138	0.3238	0.3123	0.3341	0.3116	0.3393

6500K (CCT 6243 ~ 6485K)

65L		65M		65N		65O		65P	
x	y	x	y	x	y	x	y	x	y
0.3152	0.3136	0.3145	0.3187	0.3138	0.3238	0.3123	0.3341	0.3116	0.3393
0.3145	0.3187	0.3138	0.3238	0.3123	0.3341	0.3116	0.3393	0.3109	0.3444
0.3183	0.3224	0.3177	0.3277	0.3166	0.3384	0.3161	0.3437	0.3155	0.3490
0.3188	0.3171	0.3183	0.3224	0.3177	0.3277	0.3166	0.3384	0.3161	0.3437

6500K (CCT 6020 ~ 6243K)

65Q		65R		65S		65T		65U	
x	y	x	y	x	y	x	y	x	y
0.3188	0.3171	0.3183	0.3224	0.3177	0.3277	0.3166	0.3384	0.3161	0.3437
0.3183	0.3224	0.3177	0.3277	0.3166	0.3384	0.3161	0.3437	0.3155	0.3490
0.3221	0.3261	0.3217	0.3316	0.3209	0.3426	0.3205	0.3481	0.3201	0.3536
0.3225	0.3206	0.3221	0.3261	0.3217	0.3316	0.3209	0.3426	0.3205	0.3481

7000K (CCT 7349 ~ 7690K)

70A		70B		70C		70D		70E	
x	y	x	y	x	y	x	y	x	y
0.3010	0.2989	0.2997	0.3033	0.2984	0.3077	0.2958	0.3167	0.2945	0.3211
0.2997	0.3033	0.2984	0.3077	0.2958	0.3167	0.2945	0.3211	0.2931	0.3256
0.3032	0.3073	0.3021	0.3119	0.2998	0.3211	0.2986	0.3257	0.2975	0.3303
0.3044	0.3027	0.3032	0.3073	0.3021	0.3119	0.2998	0.3211	0.2986	0.3257

7000K (CCT 7040 ~ 7349K)

70F		70G		70H		70J		70K	
x	y	x	y	x	y	x	y	x	y
0.3044	0.3027	0.3032	0.3073	0.3021	0.3119	0.2998	0.3211	0.2986	0.3257
0.3032	0.3073	0.3021	0.3119	0.2998	0.3211	0.2986	0.3257	0.2975	0.3303
0.3068	0.3113	0.3058	0.3160	0.3038	0.3256	0.3028	0.3304	0.3018	0.3351
0.3078	0.3066	0.3068	0.3113	0.3058	0.3160	0.3038	0.3256	0.3028	0.3304

(4) Chromaticity Coordinates Diagram

($I_F = 65\text{mA}$, $T_a = 25^\circ\text{C}$)

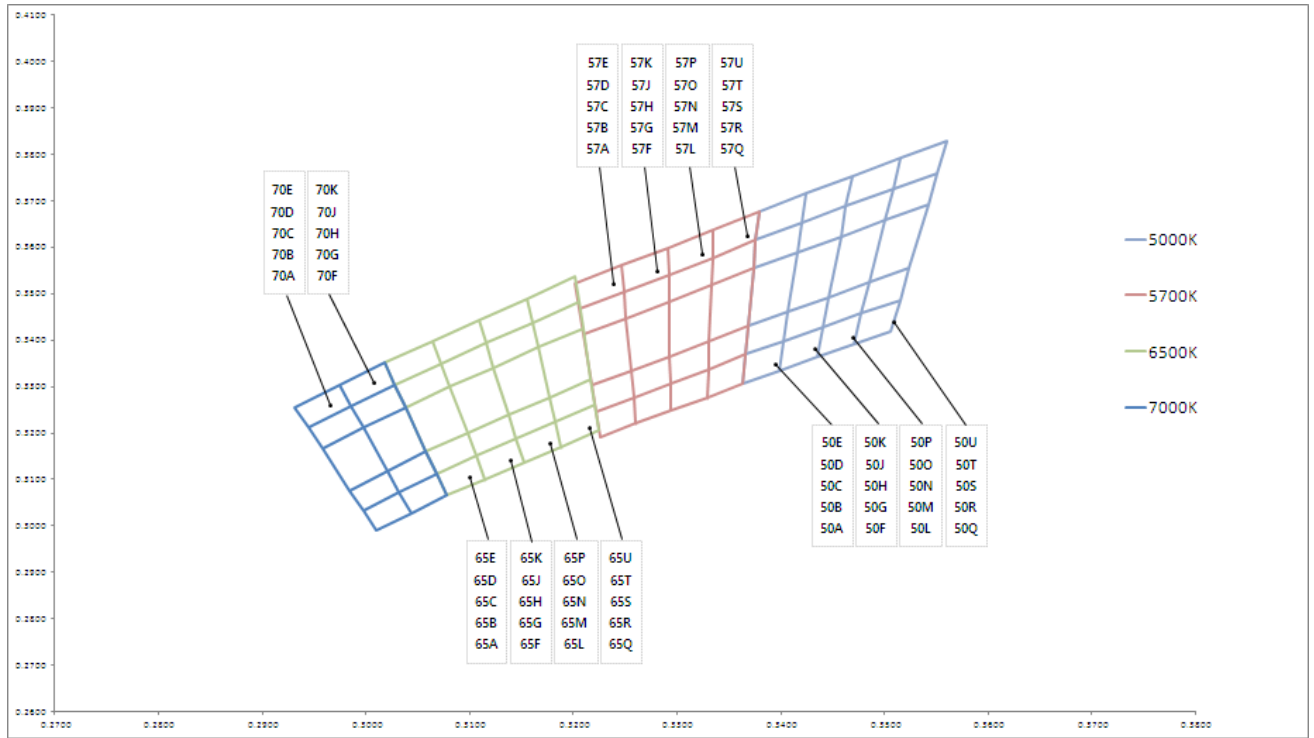

6. Color Spectrum

($I_f=65\text{mA}$, $T_a = 25^\circ\text{C}$)

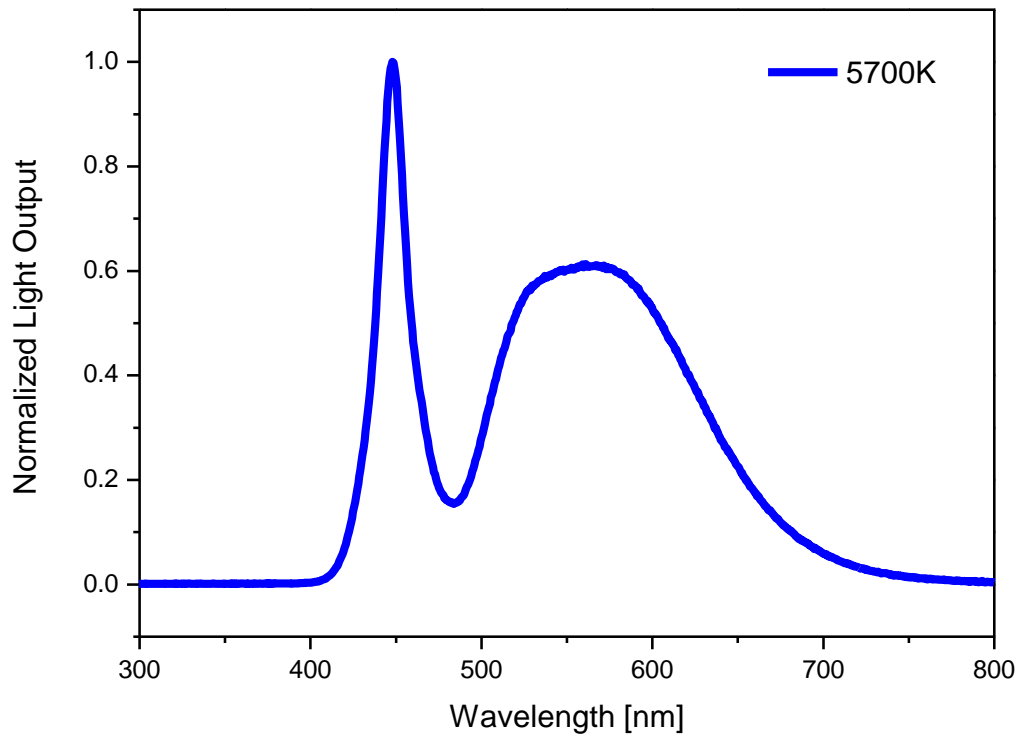

7. Characteristic Diagrams

(1) Forward Voltage vs Forward Current

(Ta = 25°C)

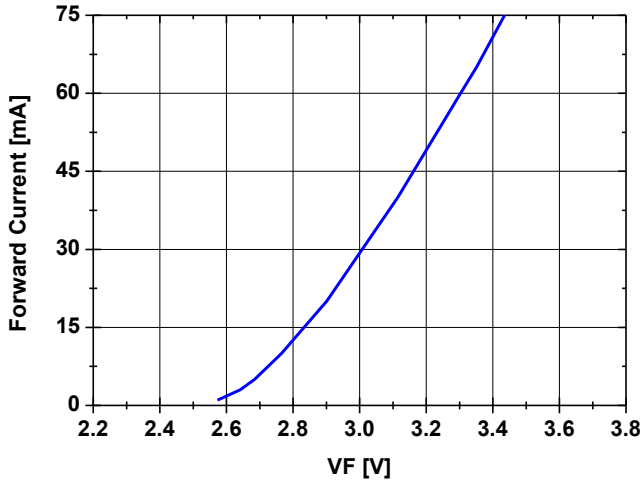

(2) Forward Current vs Relative L-Flux

(Ta = 25°C)

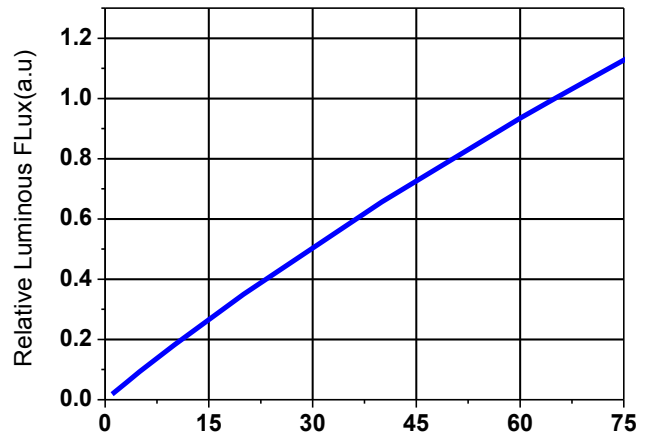

(3) ΔCIE x, ΔCIE y vs Ambient Temperature

(If = 65mA)

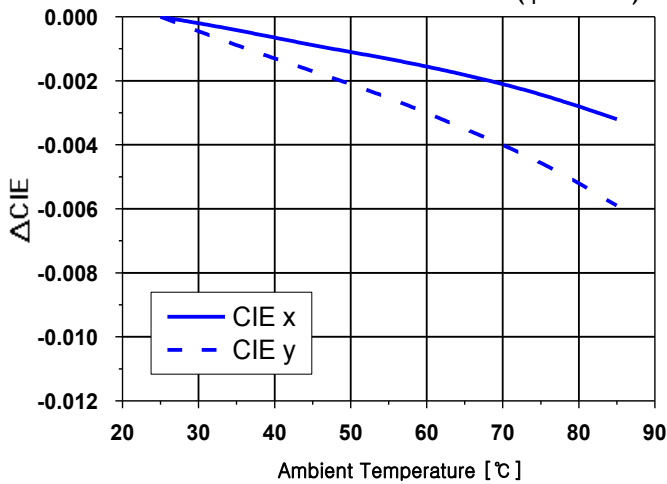

(4) ΔCIE x, ΔCIE y vs Forward Current

(Ta = 25°C)

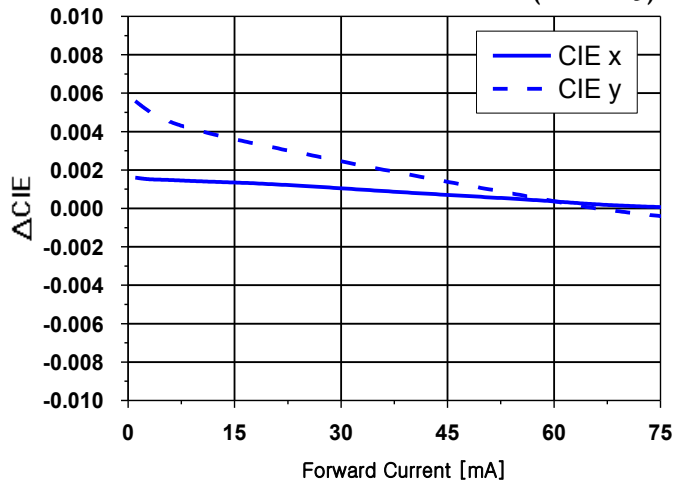

(5) Relative Luminous Flux vs Ambient Temperature

(If=65mA)

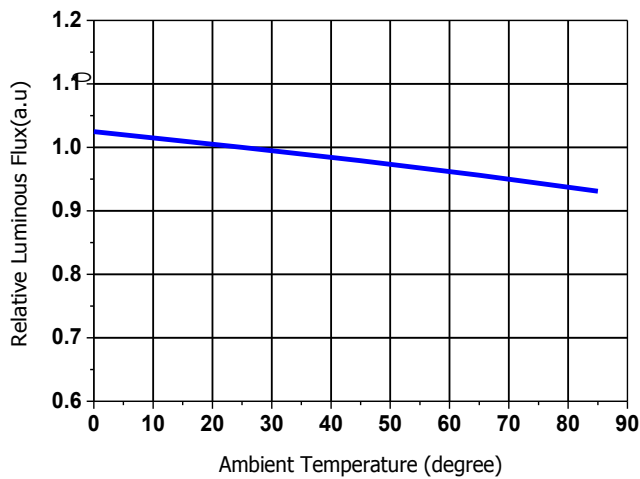

(6) Ambient Temperature vs Allowable Forward Current

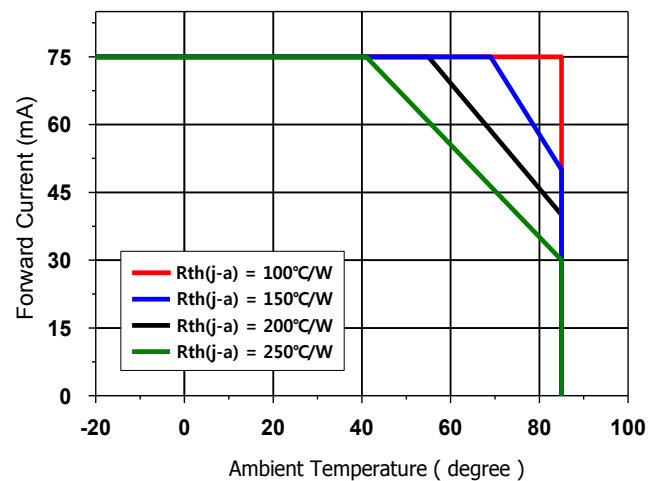

(7) View angle profile

($I_F=65\text{mA}$, $T_a=25^\circ\text{C}$)

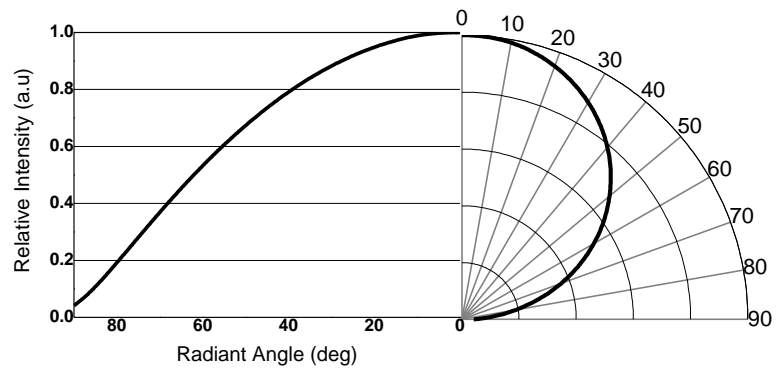

8. Reliability

(1) Test items and results

NO	Test Item	Standard Test Method	Test Conditions	Note	Number of Damaged
1	Temperature Cycle	JEITA ED-4701 100 105	-40℃ (30min)~100℃ (30min)	100 cycles	0/20
2	High Temperature Storage	JEITA ED-4701 200 201	Ta=85℃	1,000hr	0/20
3	Temperature Humidity Storage	JEITA ED-4701 100 103	Ta=85℃, RH=85%	1,000hr	0/20
4	Low Temperature Storage	JEITA ED-4701 200 202	Ta=-40℃	1,000hr	0/20
5	Steady State Operating Life	-	Ta=25℃, I _F =65mA	1,000hr	0/20
6	Steady State Operating Life of High Temperature	-	Ta=85℃, I _F =65mA	1,000hr	0/20
7	Steady State Operating Life of High Humidity Heat	-	Ta=85℃, RH=85%, I _F =65mA	1,000hr	0/20
8	Steady State Operating Life of Low Temperature	-	Ta=-40℃, I _F =65mA	1,000hr	0/20
9	Electro-Static Discharge Threshold	ESD (HBM)	1500Ω, 100pF (Forward)	5,000V	0/10
			1500Ω, 100pF (Reverse)	5,000V	0/10

(2) Criteria for judging the damage

ITEM	Symbol	Test Condition	Criteria for Judgement	
			Min.	Max.
Forward Voltage	VF	I _F =65mA	-	USL *1 × 1.2
Luminous Intensity	Iv	I _F =65mA	LSL*2 × 0.7	

*1) U.S.L. : Upper Standard Level *2) L.S.L : Lower Standard Level

9.Recommend soldering conditions

(1) Recommend soldering conditions

Reflow Soldering		Hand Soldering(Lead Part)	
	Lead Free Solder		
Pre-heat	180-200°C	Temperature Soldering Time	Max. 340°C Max. 3sec (only one time)
Pre-heat time	120sec. Max.		
Peak temperature	Max. 260°C		
Soldering Time	Max. 10sec		
Condition			

Temperature-profile

<Lead-free Solder>

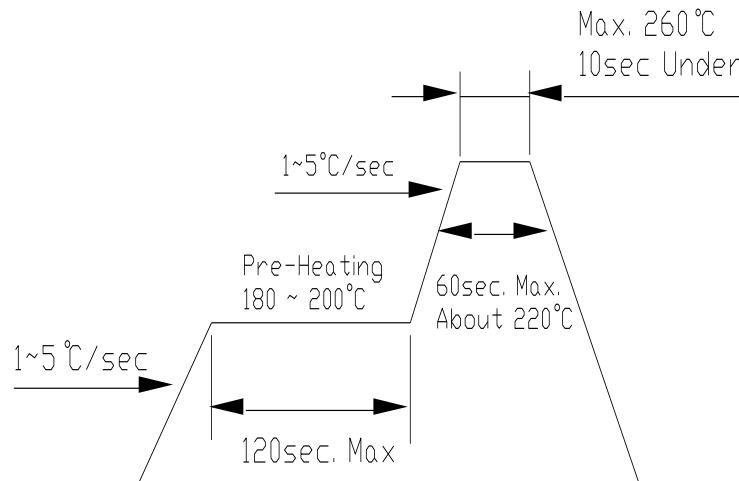

<Recommended soldering pad design>

*Unit: mm

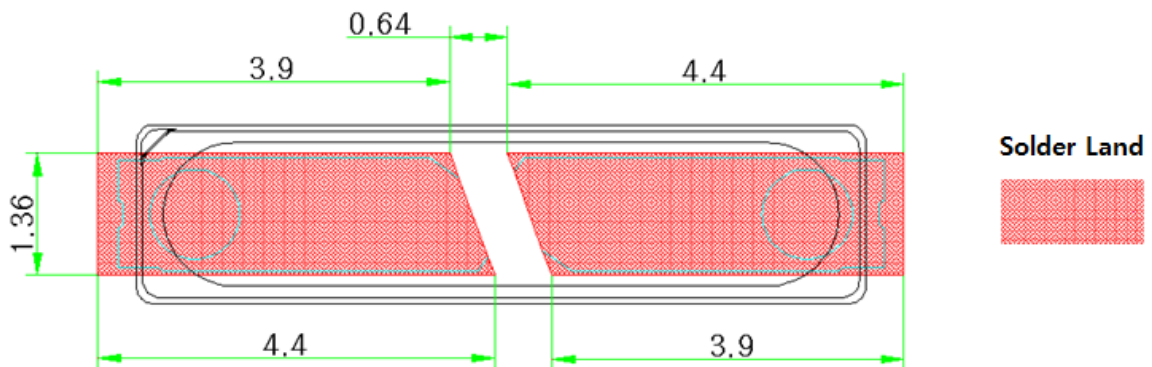

(2)Moisture Proof Package

When moisture is absorbed into the SMT package it may vaporize and expand during soldering. There is a possibility that this can cause exfoliation of the contacts and damage to the optical characteristics of the LEDs. For this reason, the moisture proof package is used to keep moisture to a minimum in the package. The moisture proof package is made of an aluminum moisture proof bag. A package of a moisture absorbent material(silica gel) is inserted into the aluminum moisture proof bag. The silica gel changes its color from blue to pink as it absorbs moisture.

(3)Storage

[Storage conditions]

Before opening the package

The LEDs should be kept at 30℃ or less and 90% RH or less. The LEDs should be used within a year. When storing the LEDs, moisture proof packaging with absorbent material(silica gel) is recommended.

After opening the package

The LEDs should be kept at 30℃ or less and 70% RH or less. The LEDs should be soldered within 168 hours(7days) after opening the package. If unused LEDs remain, they should be stored in moisture proof packages, such as sealed containers with package of moisture absorbent material(silica gel). It is also recommended to return the LEDs to the original moisture proof bag and to reseal the moisture proof bag again.

If the moisture absorbent material(silica gel) has faded away or the LEDs have exceeded the storage time, baking treatment should be performed using the following conditions.

Baking treatment : more than 24hours at 65±5℃

WOOREE LED part's electrodes and leadframes are silver plated copper alloy.

The silver surface may be affected by environments which contain corrosive substances.

Please avoid conditions which may cause the LED to corrode, tarnish or discolor.

The corrosion or discoloration might lower solderability or might affect on optical Characteristics.

Please avoid rapid transitions in ambient temperature, especially in high humidity environments where condensation can occur.

(4)Heat Generation

Thermal design of the end product is of paramount importance. Please consider the heat generation of the LED when making the system design. The coefficient of temperature increase per input electric power is affected by the thermal resistance of the circuit board and density of LED placement on the board, as well as other components. It is necessary to avoid intense heat generation and operate within the maximum ratings given in the specification.

The operating current should be decided after considering the ambient maximum temperature of LEDs.

10. Packing

(1) Taping part

unit : mm
tolerance : ± 0.1

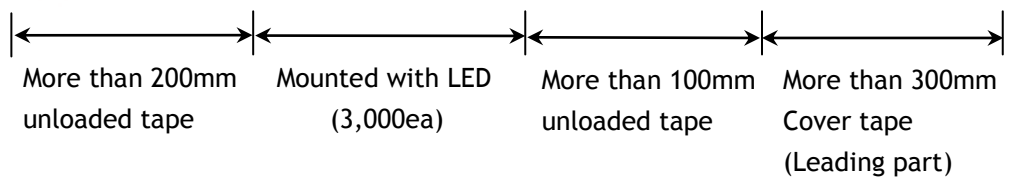
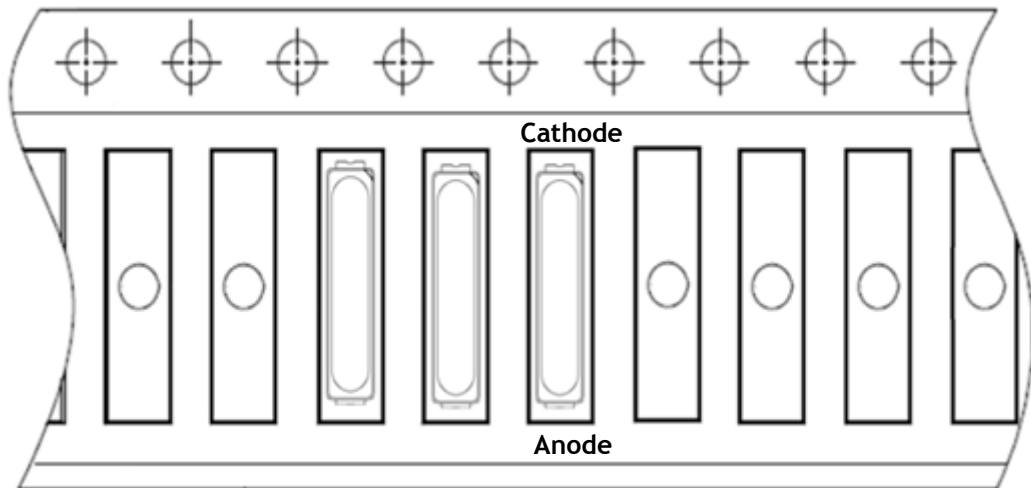
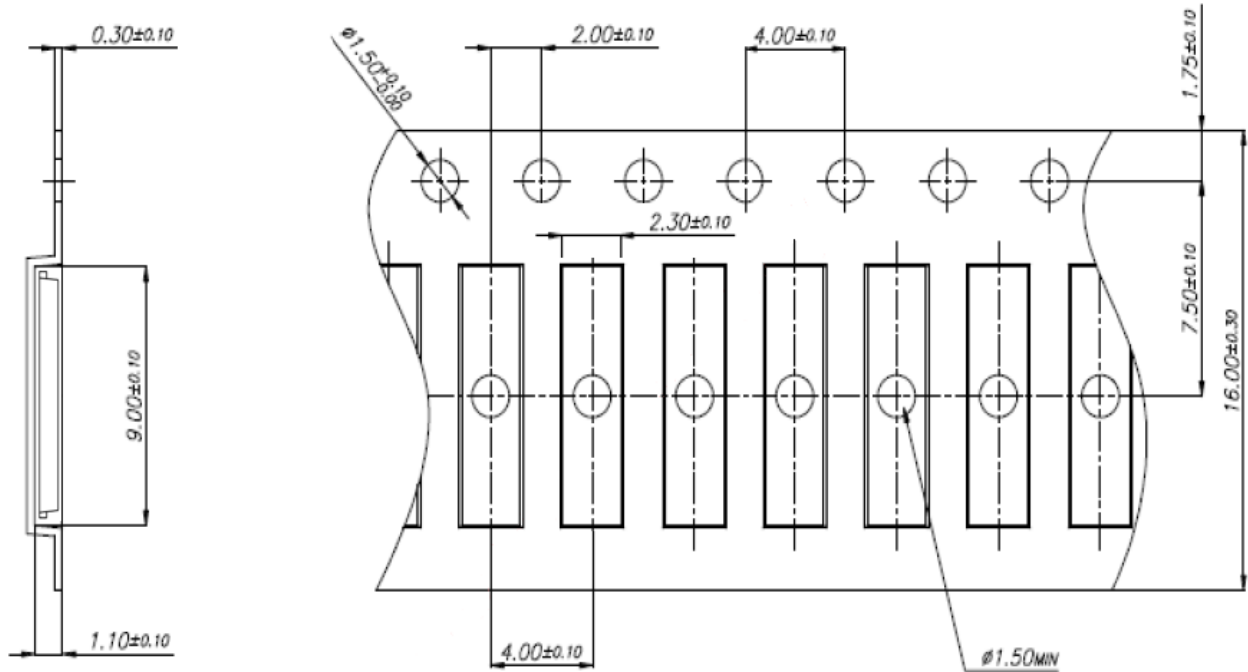

(2) Reel part (Q'ty : 3,000ea/Reel)

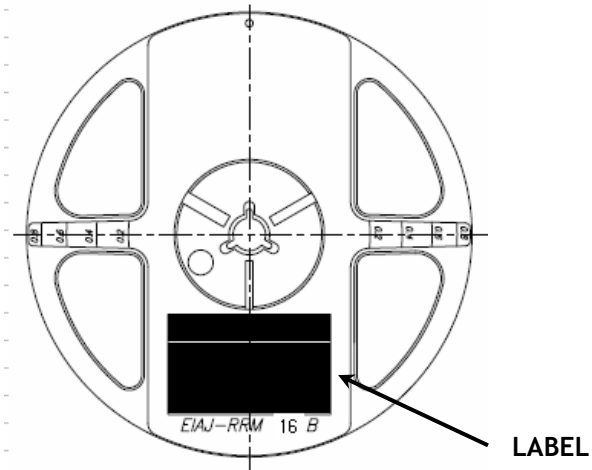

(3) Boxing

Shield Bag (with Silica gel)

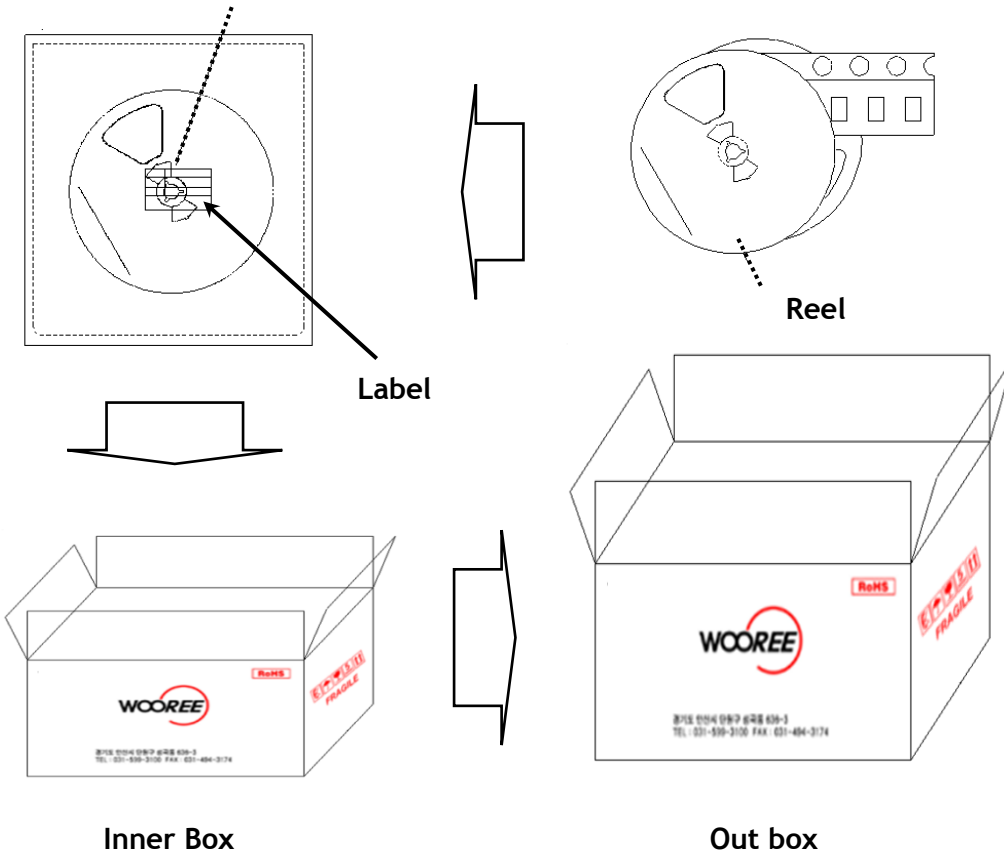

Box	Dimension (mm)	Reel/Box	Quantity/Box
Inner box	500 x 260 x 250	24 Reel max.	72,000 ea
Out box	555 x 515 x 540	96 Reel max.	288,000 ea

(4) Label Information

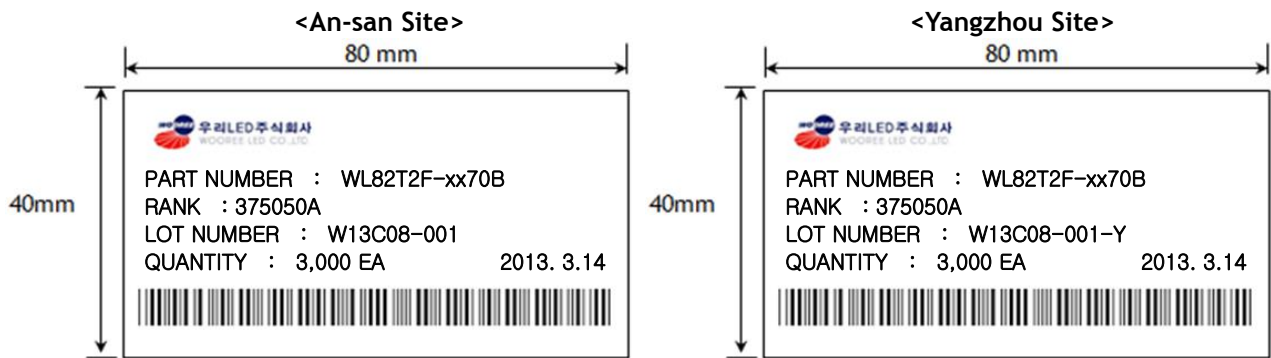

(5) Lot Number

<An-san Site>



- ① WOOREE E&L Initial
- ② Year (13 for 2013, 14 for 2014)
- ③ Month (A for Jan., B for Feb., ... , M for Dec.)
- ④ Day (01 for 1,....31 for 31)
- ⑤ WOOREE E&L Product Running Number

<Yangzhou Site>

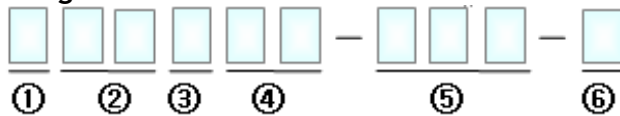

- ① WOOREE E&L Initial
- ② Year (13 for 2013, 14 for 2014)
- ③ Month (A for Jan., B for Feb., ... , M for Dec.)
- ④ Day (01 for 1,....31 for 31)
- ⑤ WOOREE E&L Product Running Number
- ⑥ WOOREE E&L Manufacturing Plant (Y for Yangzhou)

(6) Rank Code description

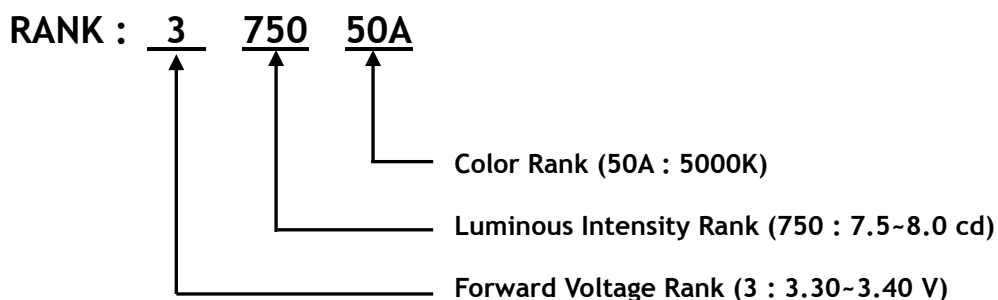

11. Revision History

Spec NO.			
Title	Specification for Approval		
Times	Date	Summary of revision	Remarks
1	2014. 05. 21	INITIAL ISSUE	R(0)